

PROLON



QUICK START **GUIDE**

VAV CONTROLLERS & WALL SENSORS

www.proloncontrols.com | info@proloncontrols.com

17 510 rue Charles, Suite 100, Mirabel, QC, J7J 1X9

REV 2.0
PL-QCK-WSENSOR/VC2000-EN

Table of Contents

Analog Sensor (PL-RS)	4
Dimensions and Wiring.....	4
Digital Sensor (PL-T200)	6
Dimensions and Wiring.....	6
Digital Sensor (PL-T500)	8
Dimensions and Wiring.....	8
Digital Sensor (PL-T1000).....	10
Installation	10
Auxiliary Analog Input.....	12
Operation	12
Changing the Setpoint.....	13
Schedule Override	13
VAV Zone Controller (PL-C1000-VAV).....	14
VAV Zone Controller (PL-VC2000).....	16
Compliance.....	18
Technical Specifications	18

© Copyright 2019 Proton. All rights reserved.

No part of this document may be photocopied or reproduced by any means, or translated to another language without prior written consent of Proton. All specifications are nominal and may change as design improvements are introduced. Proton shall not be liable for damages resulting from misapplication or misuse of its products. All trademarks are the property of their respective owners.

Dimensions and Wiring

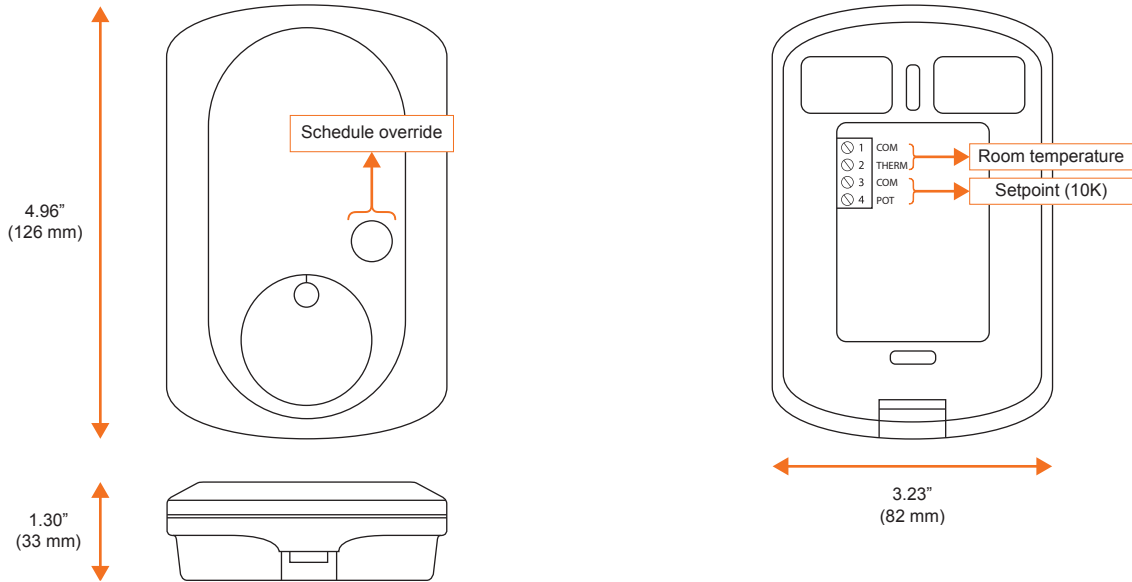

Temperature table (thermistor: 10K Type 3)

Fahrenheit	41	50	59	68	77	86	95	104
Celsius	5	10	15	20	25	30	35	40
Ohms	25395	19903	15714	12493	10000	8056	6530	5324

Dimensions and Wiring

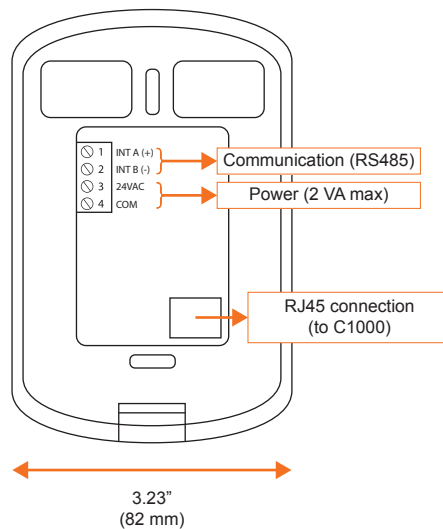
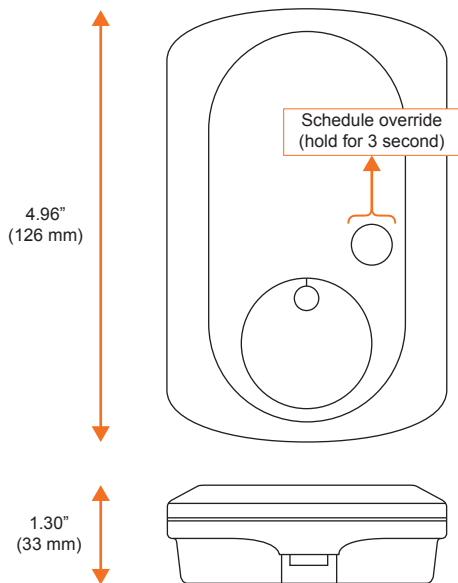

Dimensions and Wiring

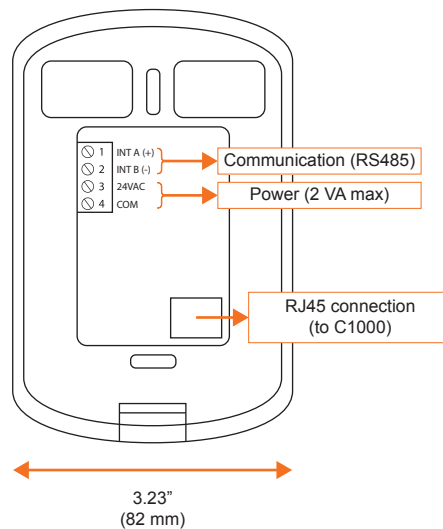
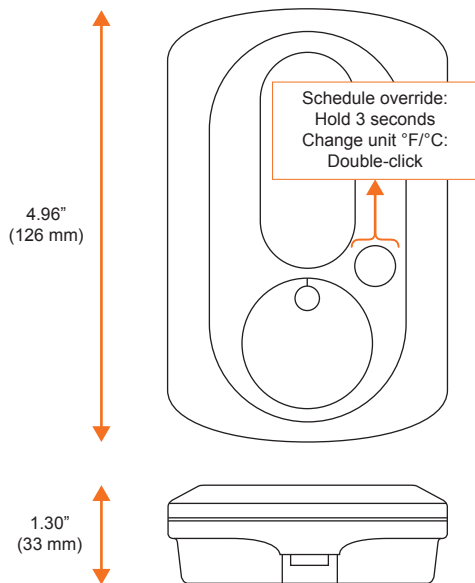

Digital Sensor (PL-T1000)

Installation

1. Open casing to remove back cover by pushing on the tab located underneath the thermostat. (See Figure 1)
2. Pull wire(s) through central hole of back cover.
3. Screw in the back cover to the wall.
4. Connect wires:
 - If using twisted pair wires:
 - Pull out screw terminal block.
 - Remove 1 cm insulation from each wire.
 - Connect the wires to the terminal blocks and reconnect the terminal blocks. (See Figure 2)
 - If using CAT5 cable:
 - Plug the cable into the RJ45 jack of the T1000 (if CAT5 cable is opened at the controller, refer to Figure 3 for pinout of the T1000's RJ45 jack).
5. Reconnect top cover.

IMPORTANT! Do not install the thermostat under the following conditions:

- Any location exposed to direct sunlight.
- On an outside wall.
- Near an air discharge grill.
- In a location where vertical air circulation is restricted.
- Near a dimmer switch.

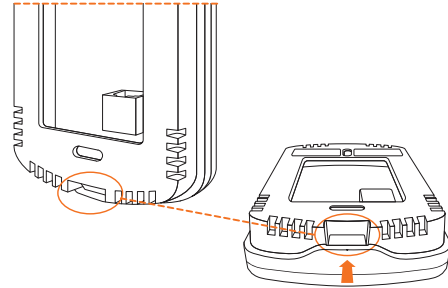

Figure 1

□	⊗	1	INT A
□	⊗	2	INT B
□	⊗	3	24 VAC
□	⊗	4	COM

Figure 2

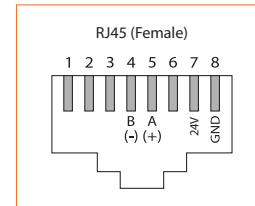
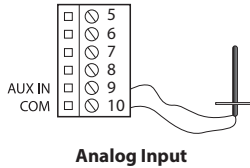

Figure 3

Auxiliary Analog Input

The T1000 has auxiliary analog input which can be used to connect another thermistor. The T1000 can be configured to use this alternate temperature reading for a variety of functions, including temperature averaging or radiant floor slab temperature. The alternate thermistor (10KΩ type 3) can be connected to the auxiliary input using the “AUX IN” and “COM” pins. (See figure below)



Operation

The T1000 is controlled using the circular touch pad on the bottom half of the thermostat. The touch pad uses capacitive sensing technology to detect finger proximity. There are no moving parts to push or rotate. The T1000 is controlled using simple scrolling, tapping or holding motions, performed around the circle of the touch pad. The center of the circle is unused.

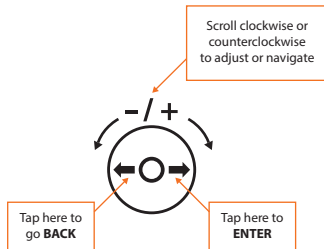

Changing the Setpoint

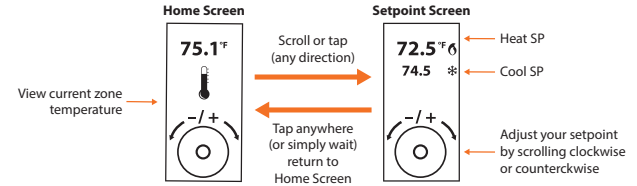

Schedule Override

The First, go to the Setpoint screen.

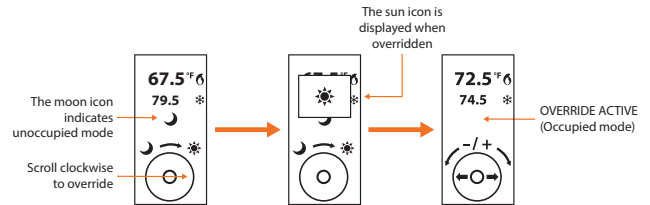

VAV Zone Controller (PL-C1000-VAV)

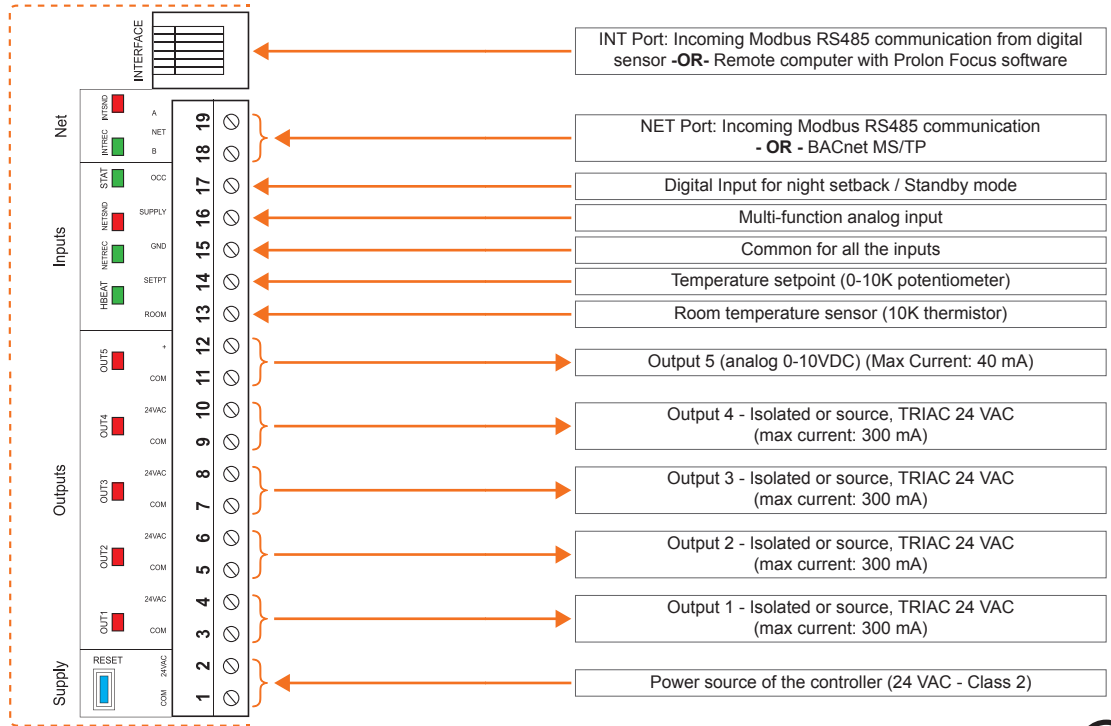

VAV Zone Controller (PL-VC2000)

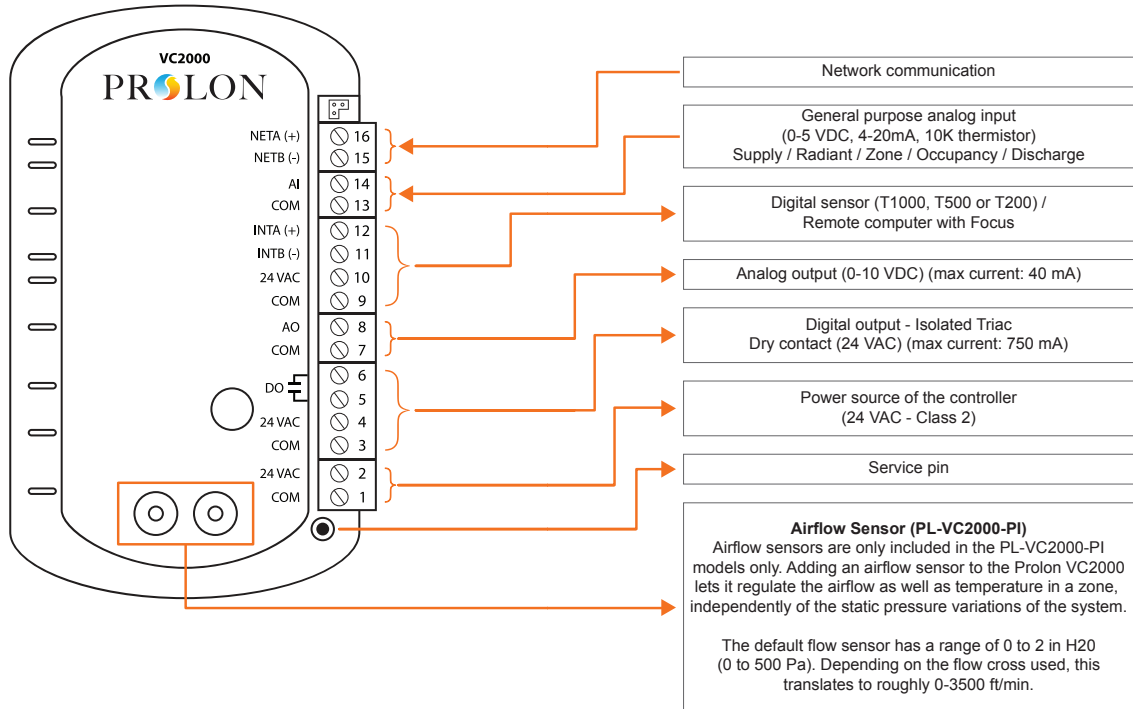

Compliance

Digital Sensor (PL-T1000)

- FCC Compliant to CFR47, Part 15, Subpart B, Class B
- Industry Canada (IC) Compliant to ICES-003, Issue 5: CAN ICES-3 (B) / NMB-3(B)
- RoHS Directive (2002/95/EC)

VAV Zone Controller (PL-C1000-VAV / PL-VC2000)

- cULus Listed; UL 916 Energy Management Equipment, File E364757, Vol.1
- CAN/CSA-C22.2 No. 2015-12, Signal Equipment
- FCC Compliant to CFR47, Part 15, Subpart B, Class B
- Industry Canada (IC) Compliant to ICES-003, Issue 5: CAN ICES-3 (B)/NMB-3(B)
- RoHS Directive (2002/95/EC)

FCC User Information

This device complies with Part 15 of the FCC Rules. Operation is subject to the following two conditions: (1) this device may not cause harmful interference, and (2) this device must accept any interference received, including interference that may cause undesired operation.

Industry Canada

This Class (B) digital apparatus meets all the requirements of the Canadian Interference-Causing Equipment regulations.

Cet appareil numérique de la Classe (B) respecte toutes les exigences du Règlement sur le matériel brouilleur du Canada.

Technical Specifications

PL-RS / PL-T200

Supply: 24 VAC \pm 10%, 50/60 Hz
Consumption: 2 VA max

PL-T500 / PL-T1000

Supply: 24 VAC \pm 10%, 50/60 Hz
Consumption: 5 VA max

PL-C1000-VAV

Supply: 24 VAC \pm 10%, 50/60 Hz
Consumption: 2 VA (Typ), 32 VA (Input)

PL-VC2000

Supply: 24 VAC \pm 10%, 50/60 Hz, Class 2
Consumption: 3 VA (Typ), 5 VA (Max),
24 VA (Input)