



Features & Options

- 100 Foot Open Air Transmission Range
- Integrates with all BAPI Receivers & Output Modules
- 4 Year Battery Life
- Waterproof Construction for Food Service Use
- NSF Certified with Food and Dishwasher Safe Materials
- Fits Most Food Bins
- Many Additional Applications Besides Food

BAPI's Wireless Food Temperature Probes remain in the food trays to measure and transmit the temperature every 30 seconds to a receiver up to 100 feet away. The receiver transforms the data into common outputs (0 to 10V, 0 to 5V, 4 to 20mA or thermistor) for input into any BAS or data acquisition system or the BAPI WAM internet monitoring service.

The food probes eliminate the need for an employee to hand record the temperatures with a thermometer for HACCP compliance. Bin clips are available to fit most stainless steel or plastic food bins. The probe is designed for dishwasher or hand washing.

Because the probes are designed for wet, dusty or dirty environments, there are many additional applications including Cooling Towers, Evaporative Coolers, Steam Humidifiers, Dusty or Wet Conveyor Systems, Aggregate Washers and Vaulted Ceiling Suspension.



3" Bent Probe without Clip

4" Bent Probe with Black Clip

Straight Probe with Black Clip



Food Probe Inside a Bin

Specifications

- Supply Power:** One 3.6 VDC Lithium
- Battery life:** 4 years @ 30 second intervals
- Battery Included:** BA/BAT-5AA-HIT, 1/2 AA
- Sensor:** Tip Sensitive Thermistor Probe
- Measurement Range:** -15° to 110°C (5° to 230°F)
- Accuracy:** ±0.55°C (±1°F), from 0° to 100°C
- Environmental Operating Range:**
 - SS Probe:** -40° to 110°C (-40° to 230°F)
 - Washing Spike Temp:** 100°C (212°F) for 8 hours
 - Humidity:** 0 to 100% RH Condensing

- Transmission Range:** Up to 100 feet open air
Up to 1,000 feet open air with a repeater
- Cleaning:** Dishwasher Safe (see Spike Temperature)
- Agency:** RoHs & NSF Certified
- FCC Approval:** FCC ID# T4FSM061025
FCC Rules Part 15, Subpart B
- Industry Canada:** IC:9067A - SM061025

Case Material: Food Safe Plastic

Probe Material:
304 Stainless Steel, 1/8" Diameter

Food Bin Bracket: Four Styles
SS Bin: Tip within 3/8" of bottom
Plastic Bin: Tip within 3/8" of bottom

Food Probe Insertion:
2" Minimum into Food, Tip Sensitive

Radio Frequency: 418 MHz @ 1mW

Transmitter Interval: ~30 seconds

Antenna: Spiral type built into case

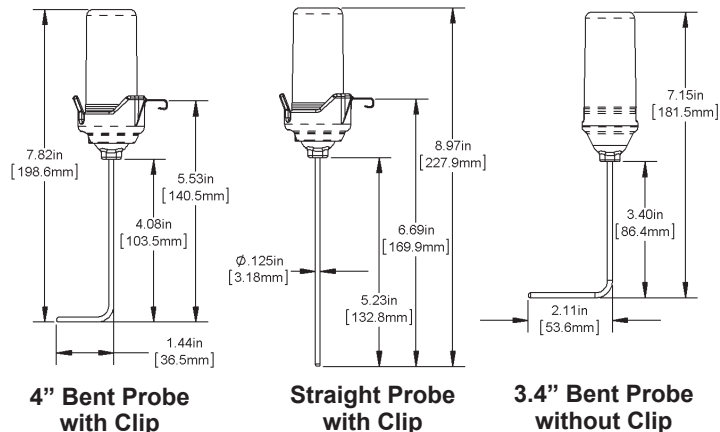



Rev. 06/04/14

Wireless Food Temperature Probes

F15

Wireless Temperature Sensing

Food Probe Ordering Information

<u>Part Number</u>	<u>Description</u>
BA/WFP-B3.....	Bent Stainless Steel Probe, 3.4" Insertion with 2.11" Bend
BA/WFP-B4.....	Bent Stainless Steel Probe 4.1" insertion with 1.4" bend
BA/WFP-S5.....	Straight Stainless Steel probe 5" insertion

Note: Each Probe includes two round blank Disk Labels.

See end of Section F for list pricing.

Accessories Ordering Information

<u>Part Number</u>	<u>Description</u>
BA/FP-CLP4	Fixed Depth Clip for Stainless Steel Square Food Bins (Black Plastic) (Use with B4 or B3 probes for 6" deep bins or S5 probe for 7" deep bins.)
BA/FP-CLP5	Fixed Depth Clip for Plastic Square Food Bins (Amber Plastic) (Use with B4 or B3 probes for 6" deep bins.)
BA/FP-CLP6	Adjustable Depth Clip for Plastic Square Bins ("6" stamp on flat) (Use with B4 or B3 probes for 6" deep bins.)
BA/FP-CLP7	Adjustable Clip for SS Square Bins ("7" stamp on flat) (Use with B4 or B3 probes for 6" deep bins or S5 probe for 7" deep bins.)
BA/FP-CLIP-KIT	Clip Kit (includes 1 each of BA/FP-CLP4, BA/FP-CLP5, BA/FP-CLP6, BA/FP-CLP7)
BA/BAT-5AA-HIT	Replacement Battery for the Wireless Food Probe, 3.6V, 1/2-AA, High Temp
BA/FP-O-RING-5	Food Probe O-Ring (5 per package)
BA/UL140	Food Probe Label Sheet, 70 Round Labels (40 numbered 1 to 40 and 30 blanks)
BA/UL-BLANK.....	Food Probe Label Sheet, 70 Round Blank Labels
BA/FP-LID-16-S	Stainless Food Bin Lid, 6 x 7", 1/6 Square w/ Ladle and Food Probe Cutout
BA/FP-LID-13-S	Stainless Food Bin Lid, 12 x 7", 1/3 Square w/ Ladle and Food Probe Cutout
BA/FP-LID-12-S	Stainless Food Bin Lid, 12.75 x 10.4", 1/2 Square w/ Ladle and Food Probe Cutout
BA/FP-HLID-7Q-R	Stainless Food Bin Hinged Lid, 9" 7-QT Round w/ Ladle and Food Probe Cutout
BA/FP-DP-5	Desiccant Pack (5 per package)
BA/FP-CRT1	Food Probe Plastic Cap Removal Tool

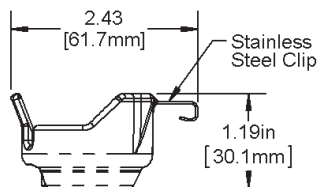

Fixed Depth Clip for Most Plastic Square Bins (Amber Plastic)

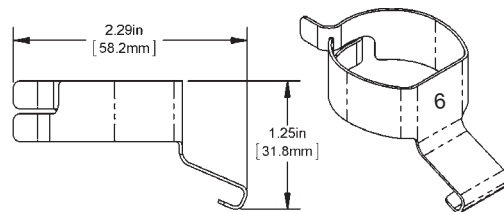
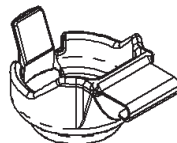

Adjustable Depth Bin Clip for Most Plastic Square Bins ("6" stamp on flat)

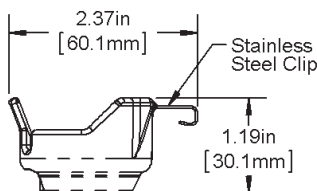

Fixed Depth Clip for Most Stainless Steel Square Bins (Black Plastic)

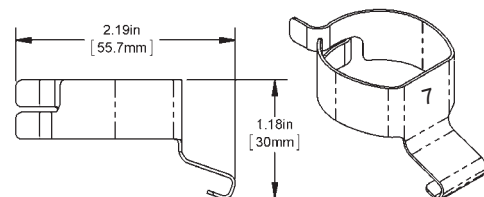
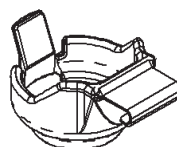

Adjustable Depth Bin Clip for Most SS Square Bins ("7" stamp on flat)

