

Application Manual



SmartVFD HVAC

Variable Frequency Drives
for Constant and Variable
Torque Applications

INDEX

Document: DPD00041B

Version release date: 23.9.09

Corresponds to application version FW0054V001

1. Startup	2
1.1 Startup Wizard	2
1.2 PID Mini-Wizard	4
1.3 Multi-pump mini-wizard	5
2. Graphic keypad - introduction	7
2.1 Keypad buttons	7
2.2 Keypad display.....	7
2.2.1 Main menu	7
2.3 Using the keypad	8
2.3.1 Editing values.....	8
2.3.2 Resetting fault	8
2.3.3 Local/remote control button	9
2.3.4 Help texts	10
2.3.5 Adding item to favourites	11
2.4 Menu structure	12
2.4.1 Quick setup	13
2.4.2 Monitor	13
2.4.3 Parameters	14
2.4.4 Diagnostics	14
2.4.5 I/O and hardware	16
2.4.6 User settings	18
2.4.7 Favourites	19
3. HVAC Application	20
3.1 Specific functions of SmartVFD	20
3.2 Example of control connections	21
3.3 HVAC Application - Quick setup parameter group.....	23
3.4 Monitor group.....	25
3.4.1 Multimonitor	25
3.4.2 Basic	25
3.4.3 Timer functions monitoring.....	27
3.4.4 PID1 controller monitoring	27
3.4.5 PID2 controller monitoring	27
3.4.6 Pump and Fan Cascade (PFC).....	28
3.4.7 Maintenance timers.....	28
3.4.8 Fieldbus data monitoring.....	28
3.5 HVAC Application - Application parameter lists	30
3.5.1 Column explanations	30
3.5.2 TTF programming	31
3.5.3 Group 3.1: Motor settings	33
3.5.4 Group 3.2: Start/Stop setup	35
3.5.5 Group 3.3: Control reference settings.....	36
3.5.6 Group 3.4: Ramp & Brakes Setup	38
3.5.7 Group 3.5: I/O Configuration.....	40
3.5.8 Group 3.7: Prohibit Frequencies	47
3.5.9 Group 3.8: Limit supervisions	48
3.5.10Group 3.9: Protections	49
3.5.11Group 3.10: Automatic reset	50
3.5.12Group 3.11: Timer functions.....	51
3.5.13Group 3.12: PID-controller 1	53

3.5.14	Group 3.13: PID-controller 2	59
3.5.15	Group 3.14: Pump and Fan Cascade.....	61
3.5.16	Group 3.15: Maintenance counters.....	62
3.5.17	Group 3.15: Fire mode	63
3.6	HVAC Application - Additional parameter information	64
3.7	HVAC Application - Fault tracing	87
3.7.1	Fault appears	87
3.7.2	Fault codes	88
3.8	Fieldbus process data out.....	91

1. STARTUP

1.1 Startup Wizard

In the *Startup Wizard*, you will be prompted for essential information needed by the drive so that it can start controlling your process. During this process, you can also select the application that best suits your needs. In the Wizard, you will need the following keypad buttons:



Left/Right arrows. Use these to easily move between digits and decimals.



Up/Down arrows. Use these to move between options in menu and to change value.



OK button. Confirm selection with this button.



Back/Reset button. Pressing this button, you can return to the previous question in the Wizard. If pressed at the first question, the Startup Wizard will be cancelled.

Once you have connected power to the drive, follow these instructions to easily set up your drive.

1	Language selection	Suomi Deutsch English Svenska Español
----------	--------------------	---

2	Daylight saving*	Russia US EU OFF
3	Time*	hh:mm:ss
4	Day*	dd.mm.
5	Year*	yyyy

* These questions appear if battery is installed

6	Run Startup Wizard?	Yes No
----------	---------------------	-----------

STOP		NotRDY		Keypad
Startup Wizard? 1				
<u>Yes</u> No 				

Push the OK button unless you want to set all parameter values manually.

7	Choose your process	Pump Fan
----------	---------------------	-------------

STOP		NotRDY		Keypad
Fan or Pump? 1				
<u>Pump</u> Fan 				

8	Set value for <i>Motor Nominal Speed</i> (according to nameplate)	Range: 24...19,200 rpm
9	Set value for <i>Motor Nominal Current</i> (according to nameplate)	Range: Varies
10	Set value for <i>Minimum Frequency</i>	Range: 0.00...50.00 Hz
11	Set value for <i>Maximum Frequency</i>	Range: 0.00...320.00 Hz

Now the Startup Wizard is done.

The Startup Wizard can be re-initiated by activating the parameter *Restore factory defaults* (par. M6.5.1) in the *Parameter backup* submenu (M6.5).

1.2 PID Mini-Wizard

The PID mini wizard is activated in the Quick Setup menu. This wizard presupposes that you are going to use the PID controller in the "one feedback / one setpoint" mode. The control place will be I/O A and the default process unit '%'.
The *PID mini wizard* asks for the following values to be set:

1	Process unit selection	(Several selections. See par. M3.12.1.4)
----------	------------------------	--

If any other process unit than '%' is selected the following questions appear: If not the Wizard will directly jump to step 5.

2	Process unit min	
3	Process unit max	
4	Process unit decimals	0...4

5	Feedback 1 source selection	See page 56 for selections.
----------	-----------------------------	-----------------------------

If one of the analogue input signals is selected the question 6 appears. Otherwise you will be taken to question 7.

6	Analogue input signal range	0 = 0...10V / 0...20mA 1 = 2...10V / 4...20mA See page 42.
----------	-----------------------------	--

7	Error inversion	0 = Normal 1 = Inverted
8	Setpoint source selection	See page 54 for selections.

If one of the analogue input signals is selected the question 9 appears. Otherwise you will be taken to question 11.

If either of the options Keypad Setpoint 1 or 2 is chosen the question 10 will appear.

9	Analogue input signal range	0 = 0...10V / 0...20mA 1 = 2...10V / 4...20mA See page 42.
10	Keypad setpoint	

11	Sleep function?	No Yes
-----------	-----------------	-----------

If option 'Yes' is selected you will be prompted for three more values:

12	Sleep frequency limit 1	0.00...320.00 Hz
13	Sleep delay 1	0...3000 s

14	Wake-up level 1	Range depends on selected process unit.
-----------	-----------------	---

1.3 Multi-pump mini-wizard

The Multi-Pump mini-wizard asks the most important questions for setting up a Multi-Pump system. The PID mini-wizard always precedes the Multi-Pump mini-wizard. The keypad will guide you through the questions as in chapter 1.2 then to be followed by the set of questions below:

15	Number of motors	1...4
16	Interlock function	0 = Not used 1 = Enabled
17	Autochange	0 = Disabled 1 = Enabled

If Autochange function is enabled the following three questions will appear. If Autochange will not be used the Wizard jumps directly to question 21.

18	Include FC	0 = Disabled 1 = Enabled
19	Autochange interval	0.0...3000.0 h
20	Autochange: Frequency limit	0.00...50.00 Hz

21	Bandwidth	0...100%
22	Bandwidth delay	0...3600 s

After this, the keypad will show the digital input and relay output configuration recommended by the application. Write these values down for future reference.

2. GRAPHIC KEYPAD - INTRODUCTION

The control keypad is the interface between the drive and the user. It features an LCD display and 9 buttons.

2.1 Keypad buttons

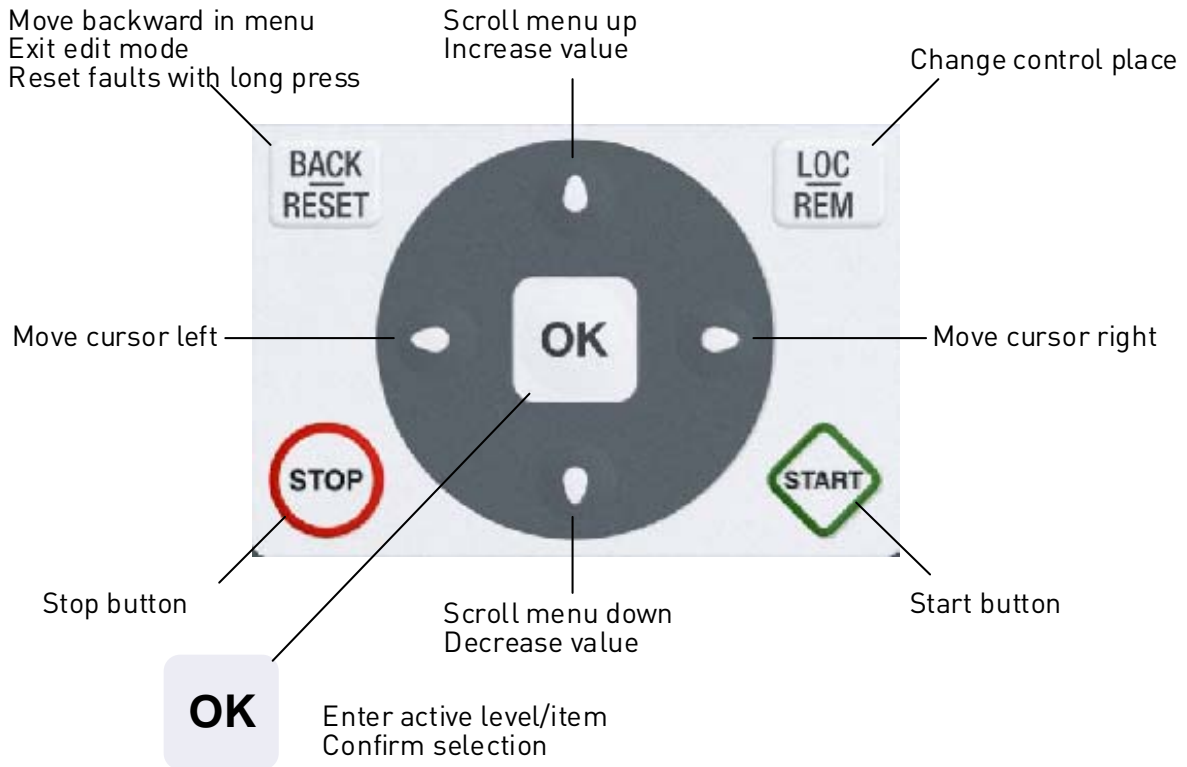

Figure 1. Keypad buttons

2.2 Keypad display

The keypad display indicates the status of the motor and the drive and any irregularities in motor or drive functions. On the display, the user sees information about his present location in the menu structure and the item displayed.

2.2.1 Main menu

The data on the control keypad are arranged in menus and submenus. Use the Up and Down arrows to move between the menus. Enter the group/item by pressing the OK button and return to the former level by pressing the Back/Reset button. See Figure 1.

The *Location field* indicates your current location. The *Status field* gives information about the present status of the drive.

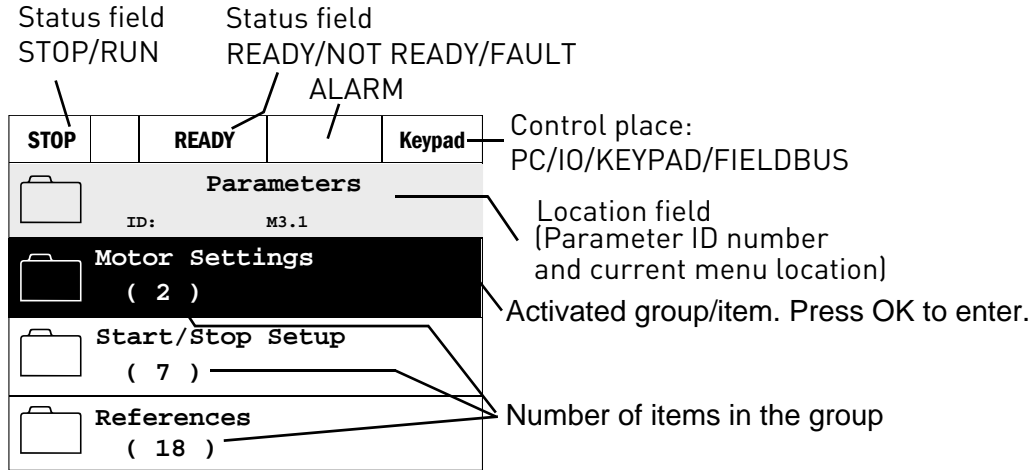

Figure 2. Main menu

2.3 Using the keypad

2.3.1 Editing values

Change value of a parameter following the procedure below:

1. Locate the parameter.
2. Enter the *Edit* mode.
3. Set new value with the arrow buttons up/down. You can also move from digit to digit with the arrow buttons left/right if the value is numerical and change then the value with the arrow buttons up/down.
4. Confirm change with OK button or ignore change by returning to previous level with Back/Reset button.

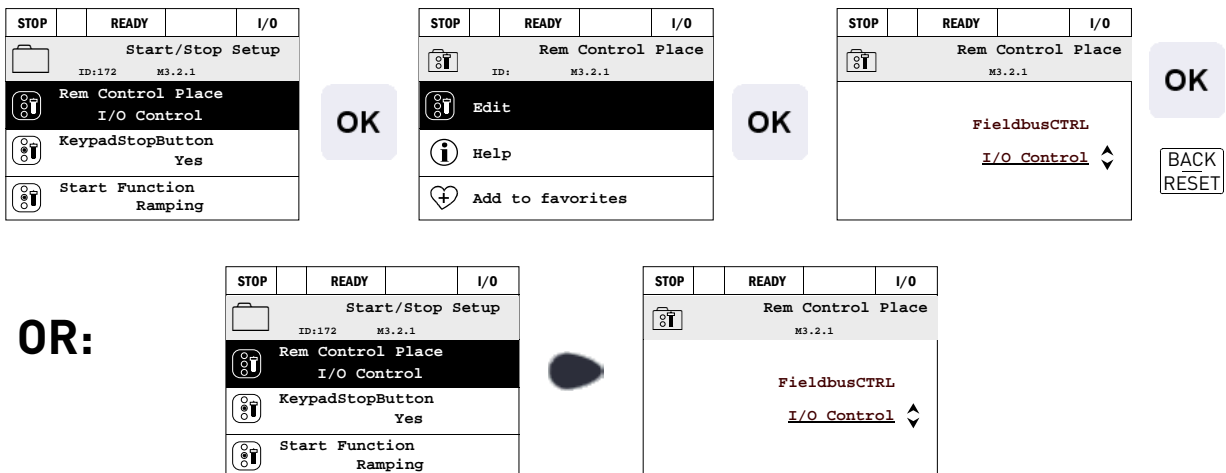

2.3.2 Resetting fault

Instructions for how to reset a fault can be found in chapter 3.7.1 on page 87.

2.3.3 Local/remote control button

The LOC/REM button is used for two functions: to quickly access the Control page and to easily change between the Local (Keypad) and Remote control places.

2.3.3.1 Changing the control place

The control place is the source of control where the drive can be started and stopped.

In the HVAC drive, the *Local control place* is always the keypad.

The *Remote control place* is determined by parameter M1.15 (I/O or Fieldbus).

Change of control place from *Remote* to *Local* (keypad).

1. Anywhere in the menu structure, push the *Loc/Rem* button.
2. Push the *Arrow up* or the *Arrow down* button to select *Local/Remote* and confirm with the *OK* button.
3. On the next display, select *Local* or *Remote* and again confirm with the *OK* button.
4. The display will return to the same location as it was when the *Loc/Rem* button was pushed.

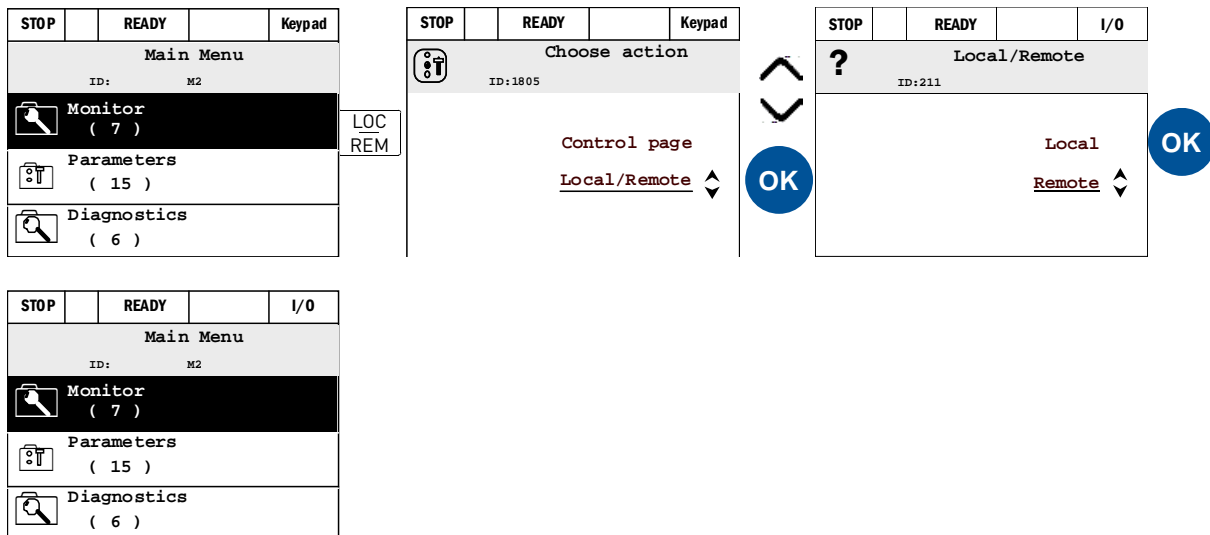

2.3.3.2 Accessing the control page

The *Control page* is meant for easy operation and monitoring of the most essential values.

1. Anywhere in the menu structure, push the *Loc/Rem* button.
2. Push the *Arrow up* or the *Arrow down* button to select *Control page* and confirm with the *OK* button.
3. The control page appears where you can set the *Keypad setpoint 2* after having pressed the *OK* button. The other values on the page are Multimonitoring values. You can choose which values appear here for monitoring (for this procedure, see page 13).

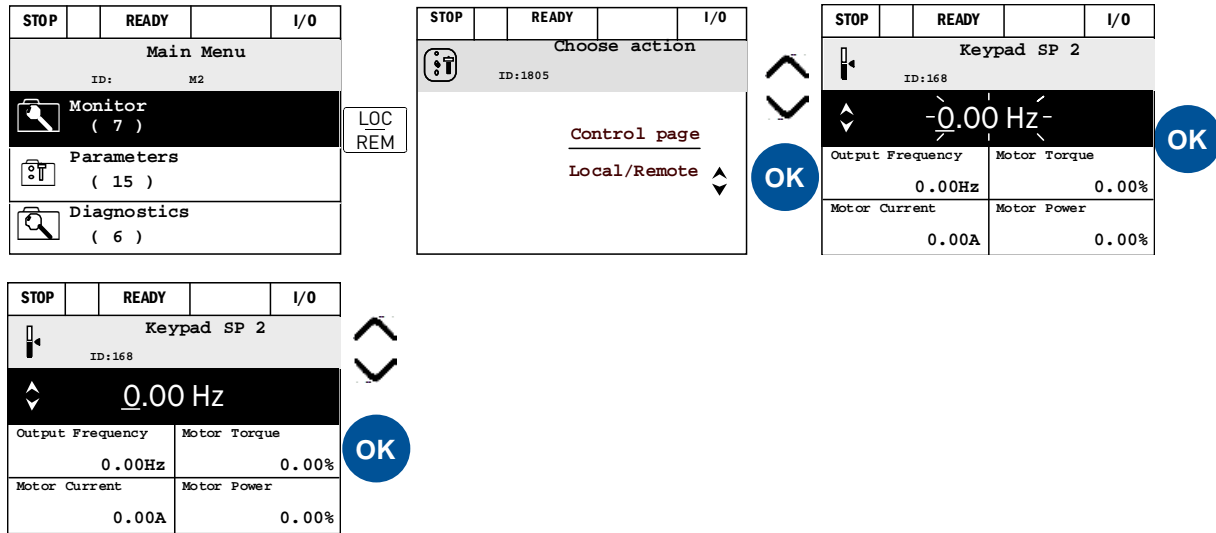

2.3.4 Help texts

The graphic keypad features instant help and information displays for various items.

All parameters offer an instant help display. Select Help and press the *OK* button.

Text information is also available for faults, alarms and the startup wizard.

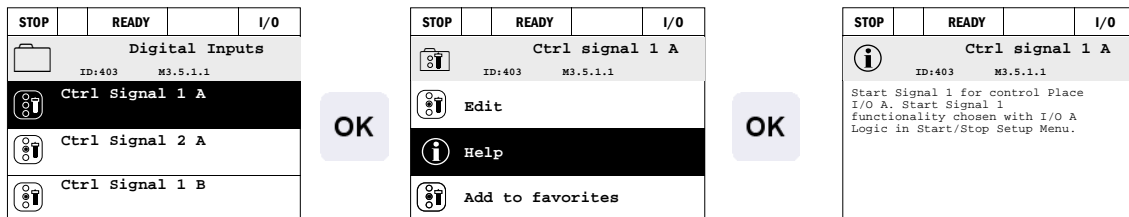

Figure 3. Help text example

2.3.5 Adding item to favourites

You might need to refer to certain parameter values or other items often. Instead of locating them one by one in the menu structure, you may want to add them to a folder called *Favourites* where they can easily be reached.

To remove an item from the Favourites, see chapter 2.4.7.

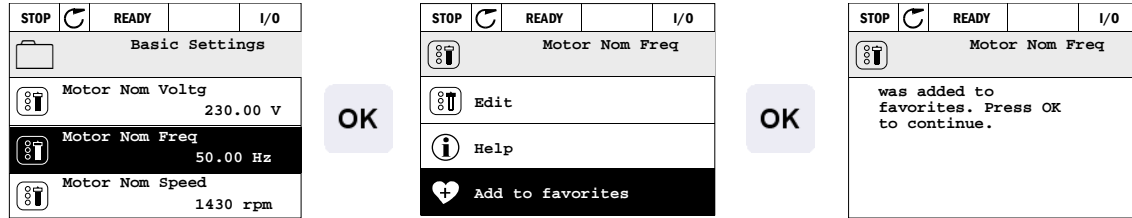

Figure 4. Adding item to Favourites

2.4 Menu structure

Click on and select the item you wish to receive more information about (electronic manual).

Quick setup	See chapter 3.3.
Monitor	Multi-monitor
	Basic
	Timer functions
	PID Controller 1
	PID Controller 2
	Multi-Pump
	Fieldbus data
Parameters	See chapter 3.
Diagnostics	Active faults
	Reset faults
	Fault history
	Total counters
	Trip counters
	Software info
I/O and hardware	Basic I/O
	Slot D
	Slot E
	Real time clock
	Keypad
	RS-485
	Ethernet
User settings	Language selections
	Application selection
	Parameter backup
Favourites	See chapter 2.3.5

Table 1. Keypad menus

2.4.1 Quick setup

The Quick Setup Menu includes the minimum set of most commonly used parameters during installation and commissioning. More detailed information on the parameters of this group you will find in chapter 3.3.

2.4.2 Monitor

Multi-monitor

On the multi-monitor page, you can collect nine values that you wish to monitor.

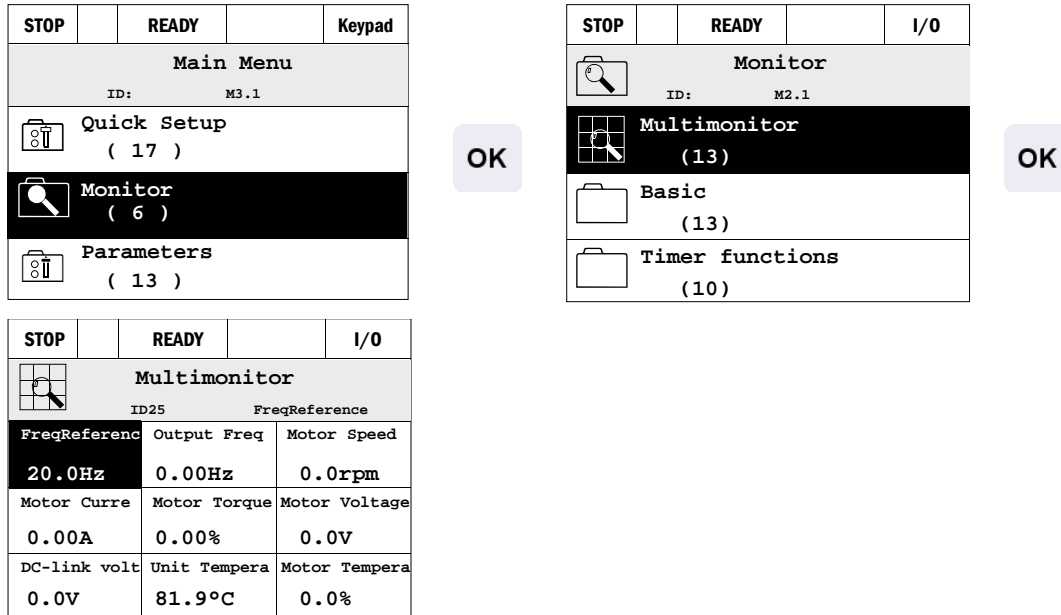

Figure 5. Multi-monitoring page

Change the monitored value by activating the value cell (with arrow buttons left/right) and clicking OK. Then choose a new item on the Monitoring values list and click OK again.

Basic

The basic monitoring values are the actual values of selected parameters and signals as well as statuses and measurements.

Timer functions

Monitoring of timer functions and the Real Time Clock. See chapter 3.4.3.

PID Controller 1

Monitoring of PID controller values. See chapters 3.4.4 and 3.4.5.

PID Controller 2

Monitoring of PID controller values. See chapters 3.4.4 and 3.4.5.

Multi-Pump

Monitoring of values related to the use of several drives. See chapter 3.4.6.

Fieldbus data

Fieldbus data shown as monitor values for debugging purposes at e.g. fieldbus commissioning. See chapter 3.4.8.

2.4.3 Parameters

Through this submenu, you can reach the application parameter groups and parameters. More information on parameters in chapter 3.

2.4.4 Diagnostics

Under this menu, you can find *Active faults*, *Reset faults*, *Fault history*, *Counters* and *Software info*.

2.4.4.1 Active faults

Menu	Function	Note
Active faults	When a fault/faults appear(s), the display with the name of the fault starts to blink. Press OK to return to the Diagnostics menu. The <i>Active faults</i> submenu shows the number of faults. Activate the fault and push OK to see the fault-time data.	The fault remains active until it is cleared with the Reset button (push for 1 s) or with a reset signal from the I/O terminal or fieldbus or by choosing <i>Reset faults</i> (see below). The memory of active faults can store the maximum of 10 faults in the order of appearance.

2.4.4.2 Reset faults

Menu	Function	Note
Reset faults	In this menu you can reset faults. For closer instructions, see chapter 3.7.1.	 CAUTION! Remove external Control signal before resetting the fault to prevent unintentional restart of the drive.

2.4.4.3 Fault history

Menu	Function	Note
Fault history	40 latest faults are stored in the Fault history.	Entering the Fault history and clicking OK on the selected fault shows the fault time data.

2.4.4.4 Total counters

Code	Parameter	Min	Max	Unit	Default	ID	Description
M4.4.1	Energy counter			Varies		2291	Amount of energy taken from supply network. No reset.
M4.4.3	Operating time			a d hh:min		2298	Control unit operating time
M4.4.4	Run time			a d hh:min		2293	Motor running time
M4.4.5	Power on time			a d hh:min		2294	Amount of time the power unit has been powered so far. No reset.
M4.4.6	Start command counter					2295	The number of times the power unit has been started.

Table 2. Diagnostics menu, Total counters parameters

2.4.4.5 Trip counters

Code	Parameter	Min	Max	Unit	Default	ID	Description
M4.5.1	Energy counter (+)			Varies		2296	Resettable energy counter.
M4.5.3	Operating time			a d hh:min		2299	Resettable.

Table 3. Diagnostics menu, Trip counters parameters

2.4.4.6 Software info

Code	Parameter	Min	Max	Unit	Default	ID	Description
M4.6.1	Version number						
M4.6.4	System load	0	100	%		2300	Load on control unit CPU.

Table 4. Diagnostics menu, Software info parameters

2.4.5 I/O and hardware

Various options-related settings are located in this menu.

2.4.5.1 Basic I/O

Monitor here the statuses of inputs and outputs.

Code	Parameter	Min	Max	Unit	Default	ID	Description
M5.1.1	Digital input 1	0	1				Status of digital input signal
M5.1.2	Digital input 2	0	1				Status of digital input signal
M5.1.3	Digital input 3	0	1				Status of digital input signal
M5.1.4	Digital input 4	0	1				Status of digital input signal
M5.1.5	Digital input 5	0	1				Status of digital input signal
M5.1.6	Digital input 6	0	1				Status of digital input signal
M5.1.7	Analog input 1 mode	1	5				Analog input signal mode
M5.1.8	Analog input 1	0	100	%			Status of analog input signal
M5.1.9	Analog input 2 mode	1	5				Analog input signal mode
M5.1.10	Analog input 2	0	100	%			Status of analog input signal
M5.1.11	Analog output 1 mode	1	5				Analog output signal mode
M5.1.12	Analog output 1	0	100	%			Status of analog output signal
M5.1.13	Relay output 1	0	1				Status of digital output signal
M5.1.14	Relay output 2	0	1				Status of digital output signal
M5.1.15	Relay output 3	0	1				Status of digital output signal

Table 5. I/O and Hardware menu, Basic I/O parameters

2.4.5.2 Option board slots

The parameters of this group depend on the option board installed. If no option board is placed in slots D or E, no parameters are visible.

Menu	Function	Note
Slot D	Settings	Option board related settings.
	Monitoring	Monitor option board-related info.
Slot E	Settings	Option board related settings.
	Monitoring	Monitor option board-related info.

2.4.5.3 Real time clock

Code	Parameter	Min	Max	Unit	Default	ID	Description
M5.4.1	Battery state	1	3			2205	Status of battery. 1 = Not installed 2 = Installed 3 = Change battery
M5.4.2	Time			hh:mm:ss		2201	Current time of day
M5.4.3	Day			dd.mm.		2202	Current date
M5.4.4	Year			yyyy		2203	Current year
M5.4.5	Daylight saving	0	3		0	2204	Daylight saving rule 0 = Off 1 = EU 2 = US 3 = Russia

Table 6. I/O and Hardware menu, Real time clock parameters

2.4.5.4 Keypad

Code	Parameter	Min	Max	Unit	Default	ID	Description
M5.6.1	Timeout time	0	600	s	0		Time after which the display returns to main menu.
M5.6.2	Contrast	30	70	%	50		Set contrast of the display (30...70%).
M5.6.3	Backlight time	0	600	s	5		Set the time until the back-light of the display turns off (0...60 min). If set to 0 s, backlight is always on.

Table 7. I/O and Hardware menu, Keypad parameters

2.4.5.5 Fieldbus

Parameters related to different fieldbus boards can also be found in the *I/O and Hardware* menu. These parameters are explained in more detail in the respective fieldbus manual.

Submenu level 1	Submenu level 2	Submenu level 3
RS-485	Common settings	Protocol
	Modbus RTU	Modbus parameters
		Modbus monitoring
	N2	N2 parameters
		N2 monitoring
BACNet	BACNet parameters	
	BACNet monitoring	
Ethernet	Common settings	
	Modbus/TCP	Modbus/TCP parameters
		Modbus/TCP monitoring

2.4.6 User settings

Code	Parameter	Min	Max	Unit	Default	ID	Description
M6.1	Language selections	1	5			802	1 = English 2 = Suomi 3 = Deutsch 4 = Svenska 5 = Español
M6.2	Application selection						
M6.5	Parameter backup	See chapter 2.4.6.1 below.					
M6.7	Drive name						

Table 8. User settings menu, General settings

2.4.6.1 Parameter backup

Code	Parameter	Min	Max	Unit	Default	ID	Description
M6.5.1	Restore factory defaults						Restores default parameter values and initiates the Startup Wizard
M6.5.2	Save to keypad						Save parameter values to keypad to e.g. copy them to another drive.
M6.5.3	Restore from keypad						Load parameter values from keypad to the drive.

Table 9. User settings menu, Parameter backup parameters

2.4.7 Favourites

Favourites are typically used to collect a set of parameters or monitoring signals from any of the keypad menus. You can add items or parameters to the Favourites folder, see chapter 2.3.5.

To remove an item or a parameter from the Favourites folder, do the following:

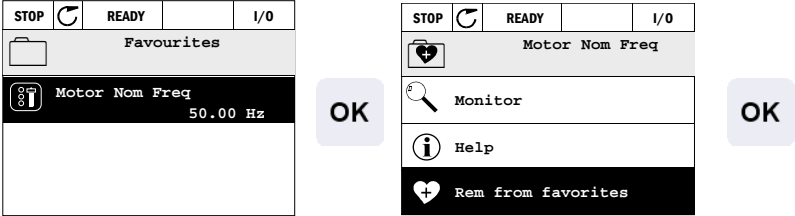

3. HVAC APPLICATION

The drive contains a preloaded application for instant use.

The parameters of this application are listed in chapter 3.5 of this manual and explained in more detail in chapter 3.6.

3.1 Specific functions of SmartVFD

The SmartVFD HVAC is an easy-to-use application for basic Pump and Fan applications where only one motor and one drive is needed and also offers extensive possibilities for PID control.

Features

- **Loc/Rem-button** for easy change between Local (keypad) and Remote control place. The remote control place is selectable by parameter (I/O or Fieldbus)
- **Control page** for easy operation and monitoring of the most essential values.
- **Run interlock** input (Damper interlock). Drive will not start before this input is activated.
- Different **pre-heat modes** used to avoid condensation problems
- **Maximum output frequency 320Hz**
- **Real-time clock and timer functions** available (optional battery required). Possible to program 3 time channels to achieve different functions on the drive (e.g. Start/Stop and Preset frequencies)
- **External PID-controller** available. Can be used to control e.g. a valve using the drive's I/O
- **Sleep mode function** which automatically enables and disables drive running with user defined levels to save energy.
- **2-zone PID-controller** (2 different feedback signals; minimum and maximum control)
- **Two setpoint sources** for the PID-control. Selectable with digital input
- **PID setpoint boost function**. If the drive is running at minimum speed, then an increase of the PID setpoint will force the drive to sleep mode
- **Feedforward function** to improve the response to the process changes
- **Process value supervision**
- Multi-Pump control

3.2 Example of control connections

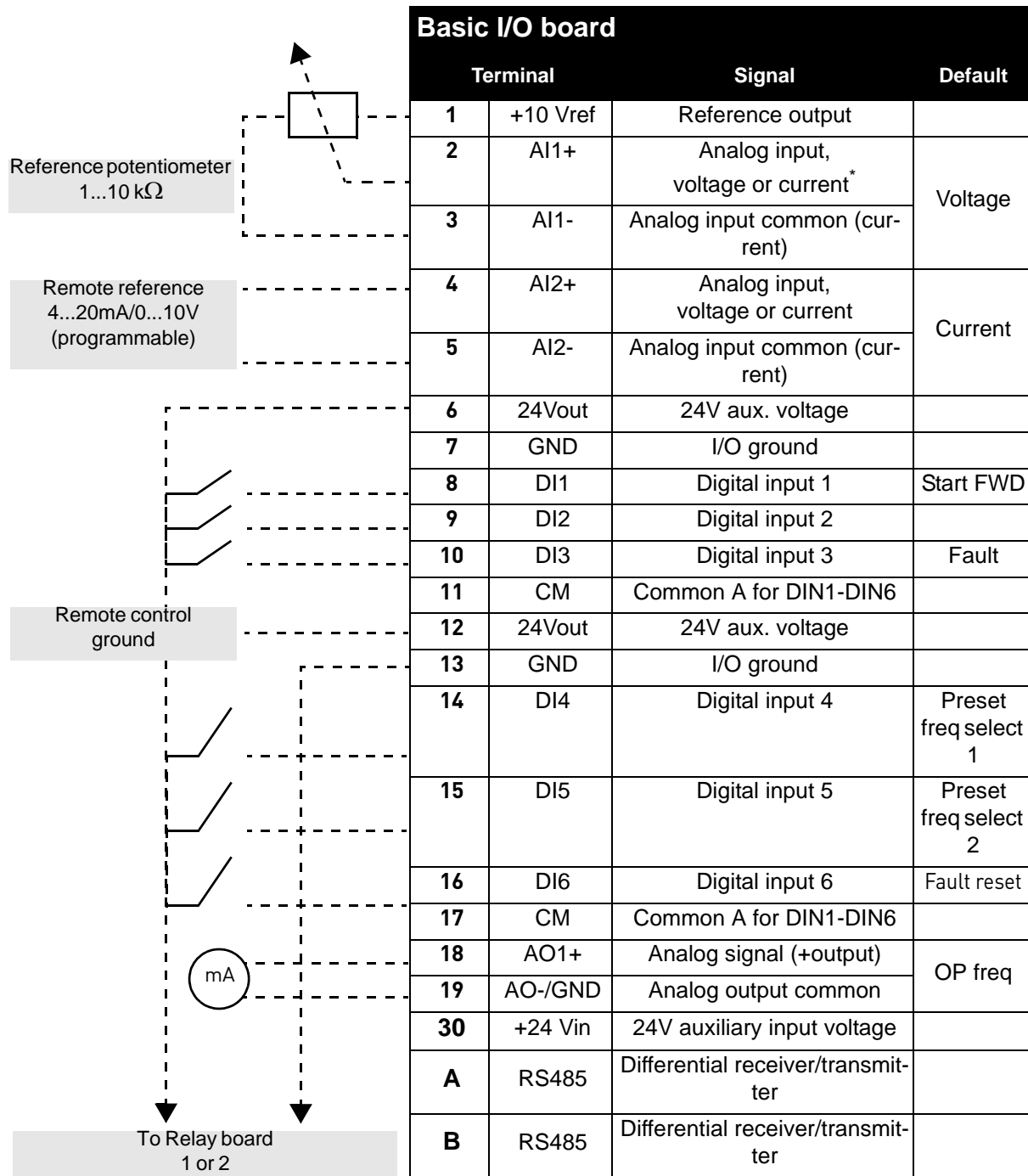

*Selectable with DIP switches, see Installation Manual

Table 10. Connection example, basic I/O board

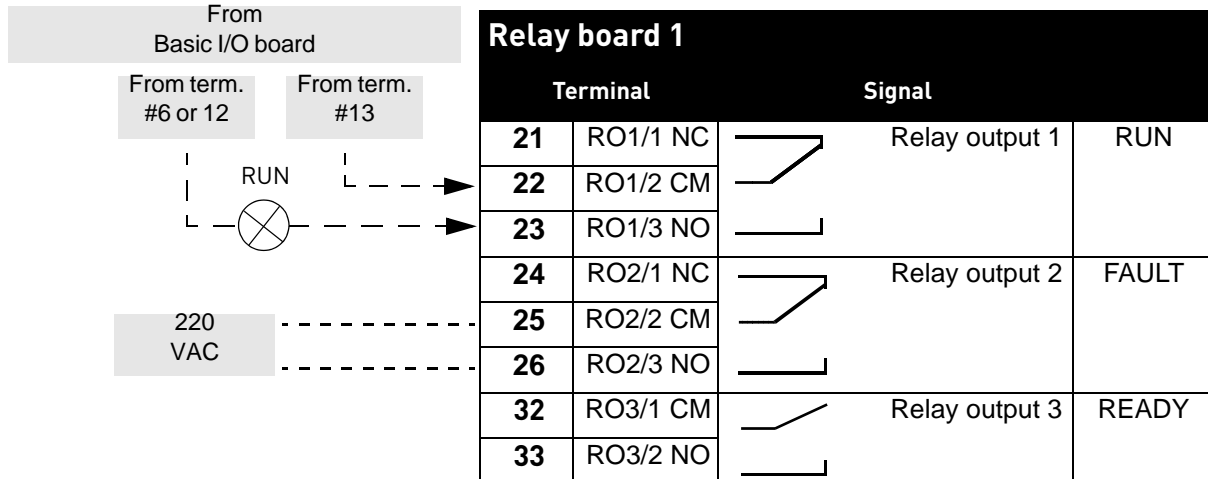

Table 11. Connection example, Relay board 1

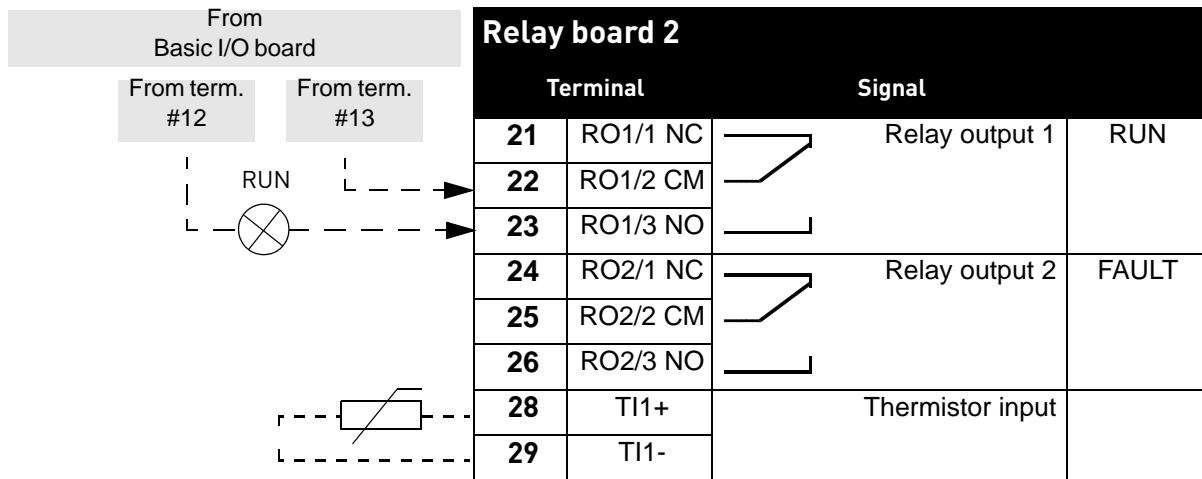

Table 12. Connection example, Relay board 2

3.3 HVAC Application - Quick setup parameter group

The Quick Setup parameter group is a collection of parameters that are most commonly used during installation and commissioning. They are collected in the first parameter group so that they can be found fast and easily. They can, however, be also reached and edited in their actual parameter groups. Changing a parameter value in the Quick setup group also changes the value of this parameter in its actual group.

Code	Parameter	Min	Max	Unit	Default	ID	Description
M1.1	Motor nominal voltage	180.0	690.0	V	Varies	110	Find this value U_n on the rating plate of the motor. See page 33.
M1.2	Motor nominal frequency	8.00	320.00	Hz	60.00	111	Find this value f_n on the rating plate of the motor. See page 33.
M1.3	Motor nominal speed	24	19200	rpm	1720	112	Find this value n_n on the rating plate of the motor.
M1.4	Motor nominal current	Varies	Varies	A	Varies	113	Find this value I_n on the rating plate of the motor.
M1.5	Motor Cos Phi	0.30	1.00		0.80	120	Find this value on the rating plate of the motor
M1.6	Motor nominal power	0.00	Varies	kW	Varies	116	Find this value P_n on the rating plate of the motor.
M1.7	Motor current limit	Varies	Varies	A	Varies	107	Maximum motor current from AC drive
M1.8	Minimum frequency	0.00	M3.3.1	Hz	Varies	101	Minimum allowed frequency reference
M1.9	Maximum frequency	M3.3.1	320.00	Hz	60.00	102	Maximum allowed frequency reference
M1.10	I/O control reference A selection	1	7		7	117	Selection of ref source when control place is I/O A. See page 36 for selections.
M1.11	Preset frequency 1	M3.3.1	300.00	Hz	10.00	105	Select with digital input: Preset frequency selection 0 (M3.5.1.16)
M1.12	Preset frequency 2	M3.3.1	300.00	Hz	15.00	106	Select with digital input: Preset frequency selection 1 (M3.5.1.17)
M1.13	Acceleration time 1	0.1	3000.0	s	20.0	103	Time to accelerate from zero to maximum frequency
M1.14	Deceleration time 1	0.1	3000.0	s	20.0	104	Time to decelerate from minimum to zero frequency
M1.15	Remote control place	1	2		1	172	Selection of remote control place (start/stop) 1 = I/O 2 = Fieldbus
M1.16	Automatic reset	0	1		0	731	0 = Disabled 1 = Enabled
M1.17	PID Mini-Wizard	0	1		0	1803	0 = Inactive 1 = Activate See chapter 1.2.

M1.18	Multi-Pump Wizard	0	1		0	0 = Inactive 1 = Activate See chapter 1.3.
-------	-------------------	---	---	--	---	--

Table 13. Quick setup parameter group

3.4 Monitor group

The drive provides you with a possibility to monitor the actual values of parameters and signals as well as statuses and measurements. Some of the values to be monitored are customizable.

3.4.1 Multimonitor

On the multi-monitor page, you can collect nine values that you wish to monitor. See page 13 for more information.

3.4.2 Basic

See Table 14 in which the basic monitoring values are presented.

NOTE!

Only Basic I/O board statuses are available in the Monitor menu. Statuses for all I/O board signals can be found as raw data in the I/O and Hardware system menu.

Check expander I/O board statuses when required in the I/O and Hardware system menu.

	Monitoring value	Unit	ID	Description
M2.2.1	Output frequency	Hz	1	Output frequency to motor
M2.2.2	Frequency reference	Hz	25	Frequency reference to motor control
M2.2.3	Motor speed	rpm	2	Motor speed in rpm
M2.2.4	Motor current	A	3	
M2.2.5	Motor torque	%	4	Calculated shaft torque
M2.2.7	Motor power	%	5	Total power consumption of AC drive
M2.2.8	Motor power	kW/hp	73	
M2.2.9	Motor voltage	V	6	
M2.2.10	DC link voltage	V	7	
M2.2.11	Unit temperature	°C	8	Heatsink temperature
M2.2.12	Motor temperature	%	9	Calculated motor temperature
M2.2.13	Analog input 1	%	59	Signal in percent of used range
M2.2.14	Analog input 2	%	60	Signal in percent of used range
M2.2.15	Analog output 1	%	81	Signal in percent of used range
M2.2.17	Drive Status Word		43	Bit coded status of drive B1=Ready B2=Run B3=Fault B6=RunEnable B7=AlarmActive B10=DC Current in stop B11=DC Brake Active B12=RunRequest B13=MotorRegulatorActive
M2.2.18	Last active fault		37	The fault code of latest activated fault that has not been reset.

	Monitoring value	Unit	ID	Description
M2.2.19	Fire mode status		1597	0=Disabled 1=Enabled 2=Activated (Enabled + DI open) 3=Test mode
M2.2.20	DIN Status Word 1		56	16-bit word where each bit represents the status of one digital input. 6 digital inputs at every slot are read. Word 1 starts from input 1 in slot A (bit0) and goes to input 4 in slot C (bit15).
M2.2.21	DIN Status Word 2		57	16-bit word where each bit represents the status of one digital input. 6 digital inputs at every slot are read. Word 2 starts from input 5 in slot C (bit0) and goes to input 6 in slot E (bit13).

Table 14. Monitoring menu items

3.4.3 Timer functions monitoring

Here you can monitor values of timer functions and the Real Time Clock.

	Monitoring value	Unit	ID	Description
M2.3.1	TC 1, TC 2, TC 3		1441	Possible to monitor the statuses of the three Time Channels (TC)
M2.3.2	Interval 1		1442	Status of timer interval
M2.3.3	Interval 2		1443	Status of timer interval
M2.3.4	Interval 3		1444	Status of timer interval
M2.3.5	Interval 4		1445	Status of timer interval
M2.3.6	Interval 5		1446	Status of timer interval
M2.3.7	Timer 1		1447	Remaining time on timer if active
M2.3.8	Timer 2		1448	Remaining time on timer if active
M2.3.9	Timer 3		1449	Remaining time on timer if active
M2.3.10	Real time clock		1450	

Table 15. Monitoring of timer functions

3.4.4 PID1 controller monitoring

	Monitoring value	Unit	ID	Description
M2.4.1	PID1 setpoint	Varies	20	Process units selected with parameter
M2.4.2	PID1 feedback	Varies	21	Process units selected with parameter
M2.4.3	PID1 error value	Varies	22	Process units selected with parameter
M2.4.4	PID1 output	%	23	Output to motor control or external control (AO)
M2.4.5	PID1 status		24	0=Stopped 1=Running 3=Sleep mode 4=In dead band (see page 53)

Table 16. PID1-controller value monitoring

3.4.5 PID2 controller monitoring

	Monitoring value	Unit	ID	Description
M2.5.1	PID2 setpoint	Varies	83	Process units selected with parameter
M2.5.2	PID2 feedback	Varies	84	Process units selected with parameter
M2.5.3	PID2 error value	Varies	85	Process units selected with parameter
M2.5.4	PID2 output	%	86	Output to external control (AO)
M2.5.5	PID2 status		87	0=Stopped 1=Running 2=In dead band (see page 53)

Table 17. PID2-controller value monitoring

3.4.6 Pump and Fan Cascade (PFC)

	Monitoring value	Unit	ID	Description
M2.6.1	Motors running		30	The number of motors running when Multi-Pump function is used.
M2.6.2	Autochange		1113	Informs the user if autochange is requested.

Table 18. Pump and fan cascade monitoring

3.4.7 Maintenance timers

	Monitoring value	Unit	ID	Description
M2.7.1	Counter 1	h/revs	1101	Status of counter (Revs*1000 or hours)
M2.7.2	Counter 2	h/revs	1102	Status of counter (Revs*1000 or hours)
M2.7.3	Counter 3	h/revs	1103	Status of counter (Revs*1000 or hours)

Table 19. Maintenance timers monitoring

3.4.8 Fieldbus data monitoring

	Monitoring value	Unit	ID	Description
M2.8.1	FB Control Word		874	Fieldbus control word used by application in bypass mode/format. Depending on the fieldbus type or profile the data can be modified before sent to application.
M2.8.2	FB speed reference		875	Speed reference scaled between minimum and maximum frequency at the moment it was received by the application. Minimum and maximum frequencies can be changed after the reference was received without affecting the reference.
M2.8.3	FB data in 1		876	Raw value of process data in 32-bit signed format
M2.8.4	FB data in 2		877	Raw value of process data in 32-bit signed format
M2.8.5	FB data in 3		878	Raw value of process data in 32-bit signed format
M2.8.6	FB data in 4		879	Raw value of process data in 32-bit signed format
M2.8.7	FB data in 5		880	Raw value of process data in 32-bit signed format
M2.8.8	FB data in 6		881	Raw value of process data in 32-bit signed format
M2.8.9	FB data in 7		882	Raw value of process data in 32-bit signed format
M2.8.10	FB data in 8		883	Raw value of process data in 32-bit signed format
M2.8.11	FB Status Word		864	Fieldbus status word sent by application in bypass mode/format. Depending on the FB type or profile the data can be modified before sent to the FB.
M2.8.12	FB speed actual		865	Actual speed in %. 0 and 100% correspond to minimum and maximum frequencies respectively. This is continuously updated depending on the momentary min and max frequencies and the output frequency.
M2.8.13	FB data out 1		866	Raw value of process data in 32-bit signed format
M2.8.14	FB data out 2		867	Raw value of process data in 32-bit signed format
M2.8.15	FB data out 3		868	Raw value of process data in 32-bit signed format
M2.8.16	FB data out 4		869	Raw value of process data in 32-bit signed format

	Monitoring value	Unit	ID	Description
M2.8.17	FB data out 5		870	Raw value of process data in 32-bit signed format
M2.8.18	FB data out 6		871	Raw value of process data in 32-bit signed format
M2.8.19	FB data out 7		872	Raw value of process data in 32-bit signed format
M2.8.20	FB data out 8		873	Raw value of process data in 32-bit signed format

Table 20. Fieldbus data monitoring

3.5 HVAC Application - Application parameter lists

Find the parameter menu and the parameter groups as guided below.

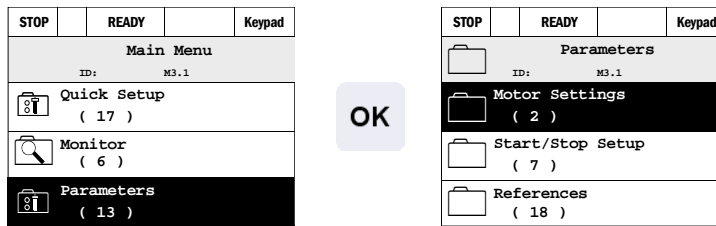

The HVAC Application embodies the following parameter groups:

Menu and Parameter group	Description
Group 3.1: Motor settings	Basic and advanced motor settings
Group 3.2: Start/Stop setup	Frequency reference setup
Group 3.3: Control reference settings	Acceleration/Deceleration setup
Group 3.4: Ramp & Brakes Setup	Start and stop functions
Group 3.5: I/O Configuration	I/O programming
Group 3.7: Prohibit Frequencies	Prohibit frequencies programming
Group 3.8: Limit supervisions	Programmable limit controllers
Group 3.9: Protections	Protections configuration
Group 3.10: Automatic reset	Auto reset after fault configuration
Group 3.11: Timer functions	Configuration of 3 timers based on Real Time Clock.
Group 3.12: PID-controller 1	Parameters for PID Controller 1. Motor control or external usage.
Group 3.13: PID-controller 2	Parameters for PID Controller 2. External usage.
Group 3.14: Pump and Fan Cascade	Parameters for Pump and Fan Cascade.
Group 3.15: Maintenance counters	Parameters for Maintenance counters.

Table 21. Parameter groups

3.5.1 Column explanations

Code = Location indication on the keypad; Shows the operator the parameter number.

Parameter = Name of parameter

Min = Minimum value of parameter

Max = Maximum value of parameter

Unit = Unit of parameter value; Given if available

Default = Value preset by factory

ID = ID number of the parameter

Description = Short description of parameter values or its function

 = Apply TTF programming to this parameter

 = More information on this parameter available; Click the parameter name

3.5.2 TTF programming

The programming of digital inputs is very flexible. There are no digital terminals assigned only for certain function. You can choose the terminal of your choice for the certain function, in other words, functions appear as parameters which the operator defines a certain input for.

Also *Time Channels* can be assigned to digital inputs with TTF. See more information on page 51.

The parameters which the *TTF programming method* is applied to are marked with the TTF-symbol (see chapter 3.5.1).

3.5.2.1 Example programming

The selectable values of the parameters programmed with the TTF method are of type

DigIN SlotA.1

in which

'**DigIN**' stands for digital input.

'**Slot_**' refers to the board; **A** and **B** are basic boards, **D** and **E** are option boards (see Figure 6). The parameter (signal) is not connected to any terminal, i.e. it is not used, if, instead of a letter, the word Slot is followed by a '0' (for example **DigIN Slot0.1**).

The number after the board letter refers to the respective terminal on the selected board. Hence, **SlotA.1** means terminal DIN1 on the basic board in board slot A.

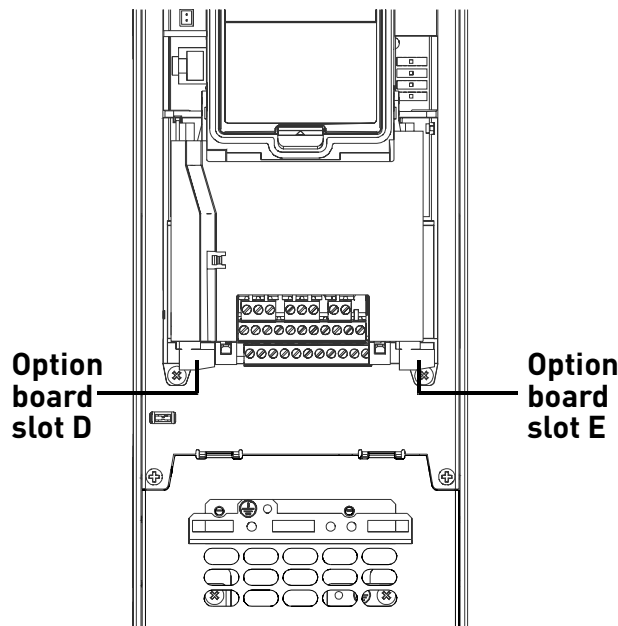

Figure 6. Option board slots

EXAMPLE:

You want to connect the *Control signal 2 A* (parameter M3.5.1.2) to digital input DI2 on Basic I/O board.

1 Locate the parameter *Control signal 2 A* (M3.5.1.2) on the keypad.

The sequence of keypad screens for step 1 is as follows:

- Screen 1:** Main Menu (ID: M3.1). Options: Quick Setup (17), Monitor (6), Parameters (13). 'Parameters' is highlighted.
- Screen 2:** Parameters (ID: M3.5). Options: References (18), Ramps and Brakes (7), I/O Config (4). 'I/O Config' is highlighted.
- Screen 3:** I/O Config (ID: M3.5.1). Options: Digital Inputs (26), Analog Inputs (36), Digital Outputs (1). 'Digital Inputs' is highlighted.

2 Enter the *Edit* mode.

The sequence of keypad screens for step 2 is as follows:

- Screen 1:** Digital Inputs (ID: 404, M3.5.1.2). Options: Ctrl Signal 1 A (DigIn SlotA.1), Ctrl Signal 2 A (DigIn Slot0.1), Ctrl Signal 1 B (DigIn Slot0.1). 'Ctrl Signal 2 A' is highlighted.
- Screen 2:** Ctrl signal 2 A (ID: M3.5.1.2). Options: Edit, Help, Add to favorites. 'Edit' is highlighted.
- Screen 3:** Ctrl signal 2 A (ID: 404, M3.5.1.2). Value: DigIN slot0.1. Fields for Min and Max are visible.

3 **Change the value:** The editable part of the value (DigIN Slot0) is underlined and blinking. Change the slot or assign to Time Channel with the arrow keys up and down. Make the terminal value (.1) editable by pressing the right key once and change the value with arrow keys up and down. Accept the change with OK button or return to previous menu level with BACK/RESET button.

3.5.3 Group 3.1: Motor settings

3.5.3.1 Basic Settings

Code	Parameter	Min	Max	Unit	Default	ID	Description
M3.1.1.1	Motor nominal voltage	Varies	Varies	V	Varies	110	Find this value U_n on the rating plate of the motor. This parameter sets the voltage at the field weakening point to $100\% * U_{nMotor}$. Note also used connection (Delta/Star).
M3.1.1.2	Motor nominal frequency	8.00	320.00	Hz	60.00	111	Find this value f_n on the rating plate of the motor.
M3.1.1.3	Motor nominal speed	24	19200	rpm	1720	112	Find this value n_n on the rating plate of the motor.
M3.1.1.4	Motor nominal current	Varies	Varies	A	Varies	113	Find this value I_n on the rating plate of the motor.
M3.1.1.5	Motor Cos Phi	0.30	1.00		0.80	120	Find this value on the rating plate of the motor
M3.1.1.6	Motor nominal power	Varies	Varies	kW	Varies	116	Find this value P_n on the rating plate of the motor.
M3.1.1.7	Motor current limit	Varies	Varies	A	Varies	107	Maximum motor current from drive
M3.1.1.8	Supply voltage	Varies	Varies	V	Varies	1200	

Table 22. Basic motor settings



3.5.3.2 Motor Control Settings

Code	Parameter	Min	Max	Unit	Default	ID	Description
M3.1.2.1	Switching frequency	1.5	Varies	kHz	Varies	601	Motor noise can be minimized using a high switching frequency. Increasing the switching frequency reduces the capacity of the drive. It is recommended to use a lower frequency when the motor cable is long in order to minimize capacitive currents in the cable.
M3.1.2.3	Motor preheat function	0	3		0	1225	0 = Not used 1 = Always in stop state 2 = Controlled by DI 3 = Temperature limit (heatsink) NOTE: Virtual digital input can be activated by RTC
M3.1.2.4	Motor preheat temperature limit	-20	80	°C	0	1226	Motor preheat is switched on when the heatsink temperature goes below this level (if par. M3.1.2.3 is set to <i>Temperature limit</i> . If limit is e.g. 10°C feeding current starts at 10 °C and stops at 11°C (1-degree hysteresis).
M3.1.2.5	Motor preheat current	0	$0.5 \cdot I_L$	A	Varies	1227	DC current for pre-heating of motor and drive in stop state. Activated by digital input or by temperature limit.

Table 23. Advanced motor settings

3.5.4 Group 3.2: Start/Stop setup

Code	Parameter	Min	Max	Unit	Default	ID	Description
M3.2.1	Remote control place	0	1		0	172	Selection of remote control place (start/stop). Can be used to change back to remote control from PC e.g. in case of a broken panel. 0=I/O control 1=Fieldbus control
M3.2.2	Local/Remote	0	1		0	211	Switch between local and remote control places 0=Remote 1=Local
M3.2.3	Keypad stop button	0	1		0	114	0=Stop button always enabled (Yes) 1=Limited function of Stop button (No)
M3.2.4	Start function	0	1		0	505	0=Ramping 1=(Conditional) flying start
M3.2.5	Stop function	0	1		0	506	0=Coasting 1=Ramping
M3.2.6	I/O A start/stop logic	0	3		0	300	CtrlSgn 1 0=Start fwd 1=Start fwd pulse(3-wire) 2=Start fwd pulse 3=AI1 threshold CrtISgn 2 0=Start fwd 1=Stop pulse (3-wire) 2=Start fwd pulse 3=AI1 threshold
M3.2.7	I/O B start/stop logic	0	3		0	363	See above.
M3.2.8	AI1 start threshold	3.00	100.00	%	5.00	185	If M3.2.6 (I/O Start/Stop Logic) is set to value 3 (AI1 threshold) the motor will start at the level set with parameter this parameter and stop at the same -2% AI1 can also be used as frequency reference at the same time.
M3.2.9	Fieldbus start logic	0	1		1	889	0=Rising edge required 1=State
M3.2.10	Keypad Master Stop	0	1		1	1806	0=Disable 1=Enable

Table 24. Start/Stop Setup menu

3.5.5 Group 3.3: Control reference settings

Code	Parameter	Min	Max	Unit	Default	ID	Description
M3.3.1	Minimum frequency	0.00	M3.3.2	Hz	0.00	101	Minimum allowed frequency reference
M3.3.2	Maximum frequency	M3.3.1	320.00	Hz	60.00	102	Maximum allowed frequency reference
M3.3.3	I/O control reference A selection	1	7		6	117	Selection of ref source when control place is I/O A 1 = Preset Frequency 0 2 = Keypad reference 3 = Fieldbus 4 = AI1 5 = AI2 6 = AI1+AI2 7 = PID 1 reference
M3.3.4	I/O control reference B selection	1	7		4	131	Selection of ref source when control place is I/O B. See above. NOTE: I/O B control place can only be forced active with digital input (M3.5.1.5).
M3.3.5	Keypad Ctrl Reference selection	1	7		2	121	Selection of ref source when control place is keypad: 1 = Preset Frequency 0 2 = Keypad 3 = Fieldbus 4 = AI1 5 = AI2 6 = AI1+AI2 7 = PID 1 reference
M3.3.6	Keypad reference	0.00	M3.3.2	Hz	0.00	184	The frequency reference can be adjusted on the keypad with this parameter.
M3.3.7	Keypad reference copy	0	2		1	181	Selects function for Run state & Reference copy when changing to Keypad control: 0 = Copy reference 1 = Copy ref & Run State 2 = No copying
M3.3.8	Fieldbus control reference selection	1	7		3	122	Selection of ref source when control place is Fieldbus: 1 = Preset frequency 0 2 = Keypad 3 = Fieldbus 4 = AI1 5 = AI2 6 = AI1+AI2 7 = PID 1 reference
M3.3.9	Preset frequency mode	0	1		0	182	0 = Binary coded 1 = Number of inputs. Preset frequency is selected according to how many of preset speed digital inputs are active
M3.3.10	Preset frequency 0	M3.3.1	M3.3.2	Hz	5.00	180	Basic preset frequency 0 when selected by Control reference parameter (M3.3.3).







	M3.3.11	Preset frequency 1	M3.3.1	M3.3.2	Hz	10.00	105	Select with digital input: Preset frequency selection 0 (M3.5.1.16)
	M3.3.12	Preset frequency 2	M3.3.1	M3.3.2	Hz	15.00	106	Select with digital input: Preset frequency selection 1 (M3.5.1.17)
	M3.3.13	Preset frequency 3	M3.3.1	M3.3.2	Hz	20.00	126	Select with digital inputs: Preset frequency selection 0 & 1
	M3.3.14	Preset frequency 4	M3.3.1	M3.3.2	Hz	25.00	127	Select with digital input: Preset frequency selection 2 (M3.5.1.18)
	M3.3.15	Preset frequency 5	M3.3.1	M3.3.2	Hz	30.00	128	Select with digital inputs: Preset frequency selection 0 & 2
	M3.3.16	Preset frequency 6	M3.3.1	M3.3.2	Hz	40.00	129	Select with digital inputs: Preset frequency selection 1 & 2
	M3.3.17	Preset frequency 7	M3.3.1	M3.3.2	Hz	50.00	130	Select with digital inputs: Preset frequency selection 0 & 1 & 2
	M3.3.18	Preset alarm frequency	M3.3.1	M3.3.2	Hz	25.00	183	This frequency used when fault response (in Group 3.9: Protections) is Alarm+preset frequency

Table 25. Control reference settings

3.5.6 Group 3.4: Ramp & Brakes Setup

Two ramps are available (two sets of acceleration time, deceleration time and ramp shape). The second ramp can be activated by a frequency threshold or a digital input. **NOTE:** Ramp 2 always has higher priority and is used if a digital input for ramp selection is activated or Ramp 2 threshold is smaller than RampFreqOut.

Code	Parameter	Min	Max	Unit	Default	ID	Description
M3.4.1	Ramp 1 shape	0.0	10.0	s	0.0	500	S-curve time ramp 1
M3.4.2	Acceleration time 1	0.1	300.0	s	Varies	103	Defines the time required for the output frequency to increase from zero frequency to maximum frequency
M3.4.3	Deceleration time 1	0.1	300.0	s	Varies	104	Defines the time required for the output frequency to decrease from maximum frequency to zero frequency
M3.4.4	Ramp 2 threshold	0.00	M3.3.2	Hz	0.00	526	Ramp 2 is activated when output frequency exceeds this limit (compared to frequency output from ramp generator). 0=Not in use. Ramp 2 can also be forced with a digital input.
M3.4.5	Ramp 2 shape	0.0	10.0	s	0.0	501	See M3.4.1.
M3.4.6	Acceleration time 2	0.0	300.0	s	10.0	502	See M3.4.2.
M3.4.7	Deceleration time 2	0.0	300.0	s	10.0	503	See M3.4.3.
M3.4.8	Ramp time optimizer	0	1		Varies	1808	0=Disable 1=Enable
M3.4.9	Ramp optimizing percentage	0.0	50.0	%	10.0	1809	Defines how big step changes in acceleration and deceleration times are allowed. 10.0% means that when running against the overvoltage controller at ramp down, the deceleration time is increased with 10.0% of the momentary value.
M3.4.10	Ramp optimizing max time	0.0	3000.0	s	Varies	1810	Ramp time optimizer does not increase the ramp over this limit.
M3.4.11	Start magnetizing time	0,00	600,00	s	0,00	516	This parameter defines the time for how long DC current is fed to motor before acceleration starts.
M3.4.12	Start magnetizing current	Varies	Varies	A	Varies	517	
M3.4.13	DC braking time at stop	0,00	600,00	s	0,00	508	Determines if braking is ON or OFF and the braking time of the DC-brake when the motor is stopping.

M3.4.14	DC brake current	Varies	Varies	A	Varies	507	Defines the current injected into the motor during DC-braking. 0 = Disabled
M3.4.15	Frequency to start DC braking at ramp stop	0,10	10,00	Hz	1,50	515	The output frequency at which the DC-braking is applied.
M3.4.16	Flux braking	0	1		0	520	0=Disabled 1=Enabled
M3.4.17	Flux braking current	0	Varies	A	Varies	519	Defines the current level for flux braking.

Table 26. Ramp and brakes setup

3.5.7 Group 3.5: I/O Configuration

3.5.7.1 *Digital inputs*

Digital inputs are very flexible to use. Parameters are functions that are connected to the required digital input terminal. The digital inputs are represented as, for example, *DigIN Slot A.2*, meaning the second input on slot A.

It's also possible to connect the digital inputs to time channels which are also represented as terminals.

NOTE! Apply TTF programming method to these parameters. For more detailed information, see chapter 3.5.2.

Code	Parameter	Default	ID	Description
M3.5.1.1	Control signal 1 A	DigIN SlotA.1	403	Start signal 1 when control place is I/O 1 (FWD)
M3.5.1.2	Control signal 2 A	DigIN Slot0.1	404	Start signal 2 when control place is I/O 1 (REV)
M3.5.1.3	Control signal 1 B	DigIN Slot0.1	423	Start signal 1 when control place is I/O B
M3.5.1.4	Control signal 2 B	DigIN Slot0.1	424	Start signal 2 when control place is I/O B
M3.5.1.5	I/O B control force	DigIN Slot0.1	425	TRUE = Force the control place to I/O B
M3.5.1.6	I/O B reference force	DigIN Slot0.1	343	TRUE = Used frequency reference is specified by I/O reference B parameter (M3.3.4).
M3.5.1.7	External fault close	DigIN SlotA.3	405	FALSE = OK TRUE = External fault
M3.5.1.8	External fault open	DigIN Slot0.2	406	FALSE = External fault TRUE = OK
M3.5.1.9	Fault reset	DigIN SlotA.6	414	Resets all active faults
M3.5.1.10	Run enable	DigIN Slot0.2	407	Must be on to set drive in Ready state
M3.5.1.11	Run interlock 1	DigIN SlotA.4	1041	Drive may be ready but start is blocked as long as interlock is on (Damper interlock).
M3.5.1.12	Run interlock 2	DigIN SlotA.5	1042	As above.
M3.5.1.13	Acceleration/Deceleration time selection	DigIN Slot0.1	408	Used for switching between ramps 1 and 2. FALSE=Ramp 1 shape, Acceleration time 1 and Deceleration time 1. TRUE=Ramp 2 shape, Acceleration time 2 and Deceleration time 2.
M3.5.1.14	Motor preheat ON	DigIN Slot0.1	1044	FALSE = No action TRUE = Uses the motor preheat DC-Current in Stop state Used when parameter M3.1.2.3 is set to 2.
M3.5.1.15	Fire Mode activation	DigIN Slot0.2	1596	FALSE = Fire Mode active TRUE = No action
M3.5.1.16	Preset frequency selection 0	DigIN Slot0.1	419	Binary selector for Preset frequencies (0-7). See page 37.
M3.5.1.17	Preset frequency selection 1	DigIN Slot0.1	420	Binary selector for Preset frequencies (0-7). See page 37.
M3.5.1.18	Preset frequency selection 2	DigIN Slot0.1	421	Binary selector for Preset frequencies (0-7). See page 37.
M3.5.1.19	Timer 1	DigIN Slot0.1	447	Rising edge starts Timer 1 programmed in Group 3.11: Timer functions parameter group
M3.5.1.20	Timer 2	DigIN Slot0.1	448	See above

M3.5.1.21	Timer 3	DigIN Slot0.1	449	See above
M3.5.1.22	PID1 setpoint boost	DigIN Slot0.1	1047	FALSE = No boost TRUE = Boost
M3.5.1.23	PID1 select setpoint	DigIN Slot0.1	1046	FALSE = Setpoint 1 TRUE = Setpoint 2
M3.5.1.24	PID2 start signal	DigIN Slot0.2	1049	FALSE = PID2 in stop mode TRUE = PID2 regulating This will have no effect if PID2 controller is not enabled in the Basic menu for PID2
M3.5.1.25	PID2 select setpoint	DigIN Slot0.1	1048	FALSE = Setpoint 1 TRUE = Setpoint 2
M3.5.1.26	Motor 1 interlock	DigIN Slot0.1	426	FALSE = Not active TRUE = Active
M3.5.1.27	Motor 2 interlock	DigIN Slot0.1	427	FALSE = Not active TRUE = Active
M3.5.1.28	Motor 3 interlock	DigIN Slot0.1	428	FALSE = Not active TRUE = Active
M3.5.1.29	Motor 4 interlock	DigIN Slot0.1	429	FALSE = Not active TRUE = Active
M3.5.1.31	Reset Maintenance counter 1	DigIN Slot0.1	490	TRUE = Reset
M3.5.1.32	Reset Maintenance counter 2	DigIN Slot0.1	491	TRUE = Reset
M3.5.1.33	Reset Maintenance counter 3	DigIN Slot0.1	492	TRUE = Reset

Table 27. Digital input settings

3.5.7.2 Analog inputs

Code	Parameter	Min	Max	Unit	Default	ID	Description
M3.5.2.1	AI1 signal selection				AnIN SlotA.1	377	Connect the AI1 signal to the analog input of your choice with this parameter. Programmable (TTF)
M3.5.2.2	AI1 signal filter time	0.00	300.00	s	1.00	378	Filter time for analog input
M3.5.2.3	AI1 signal range	0	1		0	379	0 = 0...10V / 0...20mA 1 = 2...10V / 4...20mA
M3.5.2.4	AI1 custom. min	-160.00	160.00	%	0.00	380	Custom range min setting 20% = 4-20 mA/2-10 V
M3.5.2.5	AI1 custom. max	-160.00	160.00	%	100.00	381	Custom range max setting
M3.5.2.6	AI1 signal inversion	0	1		0	387	0 = Normal 1 = Signal inverted
M3.5.2.7	AI2 signal selection				AnIN SlotA.2	388	See M3.5.2.1.
M3.5.2.8	AI2 signal filter time	0.00	300.00	s	1.00	389	See M3.5.2.2.
M3.5.2.9	AI2 signal range	0	1		1	390	0 = 0...10V / 0...20mA 1 = 2...10V / 4...20mA
M3.5.2.10	AI2 custom. min	-160.00	160.00	%	0.00	391	See M3.5.2.4.
M3.5.2.11	AI2 custom. max	-160.00	160.00	%	100.00	392	See M3.5.2.5.
M3.5.2.12	AI2 signal inversion	0	1		0	398	See M3.5.2.6.
M3.5.2.13	AI3 signal selection				AnIN Slot0.1	141	Connect the AI3 signal to the analog input of your choice with this parameter. Programmable (TTF)
M3.5.2.14	AI3 signal filter time	0.00	300.00	s	1.00	142	Filter time for analog input
M3.5.2.15	AI3 signal range	0	1		0	143	0 = 0...10V / 0...20mA 1 = 2...10V / 4...20mA
M3.5.2.16	AI3 custom. min	-160.00	160.00	%	0.00	144	20% = 4-20 mA/2-10 V
M3.5.2.17	AI3 custom. max	-160.00	160.00	%	100.00	145	Custom range max setting
M3.5.2.18	AI3 signal inversion	0	1		0	151	0 = Normal 1 = Signal inverted
M3.5.2.19	AI4 signal selection				AnIN Slot0.1	152	See M3.5.2.13. Programmable (TTF)
M3.5.2.20	AI4 signal filtering time	0.00	300.00	s	1.00	153	See M3.5.2.14.
M3.5.2.21	AI4 signal range	0	1		0	154	0 = 0...10V / 0...20mA 1 = 2...10V / 4...20mA
M3.5.2.22	AI4 custom. min	-160.00	160.00	%	0.00	155	See M3.5.2.16.
M3.5.2.23	AI4 custom. max	-160.00	160.00	%	100.00	156	See M3.5.2.17.
M3.5.2.24	AI4 signal inversion	0	1		0	162	See M3.5.2.18.
M3.5.2.25	AI5 signal selection				AnIN Slot0.1	188	Connect the AI5 signal to the analog input of your choice with this parameter. Programmable (TTF)
M3.5.2.26	AI5 signal filter time	0.00	300.00	s	1.00	189	Filter time for analog input
M3.5.2.27	AI5 signal range	0	1		0	190	0 = 0...10V / 0...20mA 1 = 2...10V / 4...20mA
M3.5.2.28	AI5 custom. min	-160.00	160.00	%	0.00	191	20% = 4-20 mA/2-10 V
M3.5.2.29	AI5 custom. max	-160.00	160.00	%	100.00	192	Custom range max setting

M3.5.2.30	AI5 signal inversion	0	1		0	198	0 = Normal 1 = Signal inverted
M3.5.2.31	AI6 signal selection				AnIN Slot0.1	199	See M3.5.2.13. Programmable (TTF)
M3.5.2.32	AI6 signal filtering time	0.00	300.00	s	1.00	200	See M3.5.2.14.
M3.5.2.33	AI6 signal range	0	1		0	201	0 = 0...10V / 0...20mA 1 = 2...10V / 4...20mA
M3.5.2.34	AI6 custom. min	-160.00	160.00	%	0.00	202	See M3.5.2.16.
M3.5.2.35	AI6 custom. max	-160.00	160.00	%	100.00	203	See M3.5.2.17.
M3.5.2.36	AI6 signal inversion	0	1		0	209	See M3.5.2.18.

Table 28. Analog input settings

3.5.7.3 Digital outputs, slot B (Basic)

Code	Parameter	Min	Max	Unit	Default	ID	Description
M3.5.3.2.1	Basic R01 function	0	35		2	11001	Function selection for Basic R01: 0 = None 1 = Ready 2 = Run 3 = General fault 4 = General fault inverted 5 = General alarm 6 = Reversed 7 = At speed 8 = Motor regulator active 9 = Preset speed active 10 = Keypad control active 11 = I/O B control activated 12 = Limit supervision 1 13 = Limit supervision 2 14 = Start command active 15 = Reserved 16 = Reserved 17 = RTC time chnl 1 control 18 = RTC time chnl 2 control 19 = RTC time chnl 3 control 20 = FB ControlWord B13 21 = FB ControlWord B14 22 = FB ControlWord B15 23 = PID1 in Sleep mode 24 = Reserved 25 = PID1 supervision limits 26 = PID2 supervision limits 27 = Motor 1 control 28 = Motor 2 control 29 = Motor 3 control 30 = Motor 4 control 31 = Reserved (Always open) 32 = Reserved (Always open) 33 = Reserved (Always open) 34 = Maintenance alarm 35 = Maintenance fault
M3.5.3.2.2	Basic R01 ON delay	0.00	320.00	s	0.00	11002	ON delay for relay
M3.5.3.2.3	Basic R01 OFF delay	0.00	320.00	s	0.00	11003	OFF delay for relay
M3.5.3.2.4	Basic R02 function	0	35		3	11004	See M3.5.3.2.1
M3.5.3.2.5	Basic R02 ON delay	0.00	320.00	s	0.00	11005	See M3.5.3.2.2.
M3.5.3.2.6	Basic R02 OFF delay	0.00	320.00	s	0.00	11006	See M3.5.3.2.3.
M3.5.3.2.7	Basic R03 function	0	35		1	11007	See M3.5.3.2.1. Not visible if only 2 output relays are installed

Table 29. Digital output settings on basic I/O board

3.5.7.4 Expander slots D and E digital outputs

Code	Parameter	Min	Max	Unit	Default	ID	Description
	Application dynamic output list						Shows only parameters for existing outputs in slot D/E. Selections as in Basic R01 Not visible if no digital output exists in slot D/E.

Table 30. Slot D/E digital outputs

3.5.7.5 Analog outputs, Slot A (Basic)

Code	Parameter	Min	Max	Unit	Default	ID	Description
M3.5.4.1.1	AO1 function	0	19		2	10050	0=TEST 0% (Not used) 1=TEST 100% 2=Output freq (0 -fmax) 3=Freq reference (0-fmax) 4=Motor speed (0 - Motor nominal speed) 5=Output current (0-I _{nMotor}) 6=Motor torque (0-T _{nMotor}) 7=Motor power (0-P _{nMotor}) 8=Motor voltage (0-U _{nMotor}) 9=DC link voltage (0-1000V) 10=PID1 output (0-100%) 11=PID2 output (0-100%) 12=ProcessDataIn1 13=ProcessDataIn2 14=ProcessDataIn3 15=ProcessDataIn4 16=ProcessDataIn5 17=ProcessDataIn6 18=ProcessDataIn7 19=ProcessDataIn8 NOTE: For ProcessDataIn, e.g. value 5000 = 50.00%
M3.5.4.1.2	AO1 filter time	0.00	300.00	s	1.00	10051	Filtering time of analog output signal. See M3.5.2.2 0 = No filtering
M3.5.4.1.3	AO1 minimum	0	1		0	10052	0 = 0 mA / 0V 1 = 4 mA / 2V Note the difference in analog output scaling in parameter M3.5.4.1.4.
M3.5.4.1.4	AO1 minimum scale	Varies	Varies	Varies	0.0	10053	Min scale in process unit (depends on selection of AO1 function)
M3.5.4.1.5	AO1 maximum scale	Varies	Varies	Varies	0.0	10054	Max scale in process unit (depends on selection of AO1 function)

Table 31. Basic I/O board analog output settings

3.5.7.6 *Expander slots D to E analog outputs*

Code	Parameter	Min	Max	Unit	Default	ID	Description
	Application dynamic output list						Shows only parameters for existing outputs in slot D/E. Selections as in Basic AO1 Not visible if no analog output exists in slot D/E.

Table 32. Slot D/E analog outputs

3.5.8 Group 3.7: Prohibit Frequencies

In some systems it may be necessary to avoid certain frequencies due to mechanical resonance problems. By setting up prohibit frequencies it is possible to skip these ranges.

Code	Parameter	Min	Max	Unit	Default	ID	Description
M3.7.1	Prohibit frequency range 1 low limit	-1,00	320,00	Hz	0,00	509	0 = Not used
M3.7.2	Prohibit frequency range 1 high limit	0,00	320,00	Hz	0,00	510	0 = Not used
M3.7.3	Prohibit frequency range 2 low limit	0,00	320,00	Hz	0,00	511	0 = Not used
M3.7.4	Prohibit frequency range 2 high limit	0,00	320,00	Hz	0,00	512	0 = Not used
M3.7.5	Prohibit frequency range 3 low limit	0,00	320,00	Hz	0,00	513	0 = Not used
M3.7.6	Prohibit frequency range 3 high limit	0,00	320,00	Hz	0,00	514	0 = Not used
M3.7.7	Ramp time factor	0,1	10,0	Times	1,0	518	Multiplier of the currently selected ramp time between prohibit frequency limits.
M3.7.8	Resonance sweep acc/dec time	0.1	3000.0	s	20.0	1812	Acceleration and deceleration times to be used during resonance sweep.

Table 33. Prohibit frequencies

3.5.9 Group 3.8: Limit supervisions

Choose here:

1. One or two (M3.8.1/M3.8.5) signal values for supervision.
2. Whether the low or high limits are supervised (M3.8.2/M3.8.6)
3. The actual limit values (M3.8.3/M3.8.7).
4. The hystereses for the set limit values (M3.8.4/M3.8.8).

Code	Parameter	Min	Max	Unit	Default	ID	Description
M3.8.1	Supervision #1 item selection	0	7		0	1431	0 = Output frequency 1 = Frequency reference 2 = Motor current 3 = Motor torque 4 = Motor power 5 = DC-link voltage 6 = Analog input 1 7 = Analog input 2
M3.8.2	Supervision #1 mode	0	2		0	1432	0 = Not used 1 = Low limit supervision (output active over limit) 2 = High limit supervision (output active under limit)
M3.8.3	Supervision #1 limit	-200.000	200.000	Varies	25.00	1433	Supervision limit for selected item. Unit appears automatically.
M3.8.4	Supervision #1 limit hysteresis	-200.000	200.000	Varies	5.00	1434	Supervision limit hysteresis for selected item. Unit appears automatically.
M3.8.5	Supervision #2 item selection	0	7		1	1435	See M3.8.1
M3.8.6	Supervision #2 mode	0	2		0	1436	See M3.8.2
M3.8.7	Supervision #2 limit	-200.000	200.000	Varies	40.00	1437	See M3.8.3
M3.8.8	Supervision #2 limit hysteresis	-200.000	200.000	Varies	5.00	1438	See M3.8.4

Table 34. Limits supervision settings

3.5.10 Group 3.9: Protections

Code	Parameter	Min	Max	Unit	Default	ID	Description
M3.9.1	Response to Analog input low fault	0	4		0	700	0=No action 1=Alarm 2=Alarm, set preset fault frequency (par. M3.3.18) 3=Fault (Stop according to stop mode) 4=Fault (Stop by coasting)
M3.9.2	Response to external fault	0	3		2	701	0 = No action 1 = Alarm 2 = Fault (Stop according to stop mode) 3 = Fault (Stop by coasting)
M3.9.3	Response to Input phase fault	0	3		3	730	See above
M3.9.4	Undervoltage fault	0	1		0	727	0 = Fault stored in history 1 = Fault not stored in history
M3.9.5	Response to output phase fault	0	3		2	702	See M3.9.2
M3.9.6	Motor thermal protection	0	3		2	704	See M3.9.2
M3.9.7	Motor ambient temperature factor	-20.0	100.0	°C	40.0	705	Ambient temperature in °C
M3.9.8	Motor thermal zero speed cooling	5.0	150.0	%	Varies	706	Defines the cooling factor at zero speed in relation to the point where the motor is running at nominal speed without external cooling.
M3.9.9	Motor thermal time constant	1	200	min	Varies	707	The time constant is the time within which the calculated thermal stage has reached 63% of its final value.
M3.9.10	Motor thermal loadability factor	0	150	%	100	708	
M3.9.11	Motor stall fault	0	3		0	709	See M3.9.2
M3.9.12	Underload fault (broken belt/dry pump)	0	3		0	713	See M3.9.2
M3.9.13	Response to Fieldbus communication fault	0	4		3	733	See M3.9.1
M3.9.14	Slot communication fault	0	3		2	734	See M3.9.2
M3.9.15	Thermistor fault	0	3		0	732	See M3.9.2
M3.9.16	Soft fill timeout	0	3		2	748	See M3.9.2
M3.9.17	Response to PID1 supervision fault	0	3		2	749	See M3.9.2
M3.9.18	Response to PID2 supervision fault	0	3		2	757	See M3.9.2

Table 35. Protections settings

3.5.11 Group 3.10: Automatic reset

Code	Parameter	Min	Max	Unit	Default	ID	Description
M3.10.1	Automatic reset	0	1		0	731	0 = Disabled 1 = Enabled
M3.10.2	Restart function	0	1		1	719	The start mode for Automatic reset is selected with this parameter: 0 = Flying start (conditional) 1 = According to par. M3.2.4
M3.10.3	Wait time	0,10	10000,0	s	0,50	717	Wait time before the first reset is executed.
M3.10.4	Trial time	0,00	10000,0	s	60,00	718	When the trial time has elapsed, and the fault is still active, the drive will trip to fault.
M3.10.5	Number of trials	1	10		4	759	NOTE: Total number of trials (irrespective of fault type)
M3.10.6	Autoreset: Undervoltage	0	1		1	720	Autoreset permitted? 0 = No 1 = Yes
M3.10.7	Autoreset: Overvoltage	0	1		1	721	Autoreset permitted? 0 = No 1 = Yes
M3.10.8	Autoreset: Overcurrent	0	1		1	722	Autoreset permitted? 0 = No 1 = Yes
M3.10.9	Autoreset: AI low	0	1		1	723	Autoreset permitted? 0 = No 1 = Yes
M3.10.10	Autoreset: Unit over-temperature	0	1		1	724	Autoreset permitted? 0 = No 1 = Yes
M3.10.11	Autoreset: Motor over-temperature	0	1		1	725	Autoreset permitted? 0 = No 1 = Yes
M3.10.12	Autoreset: External fault	0	1		0	726	Autoreset permitted? 0 = No 1 = Yes
M3.10.13	Autoreset: Underload fault	0	1		0	738	Autoreset permitted? 0 = No 1 = Yes

Table 36. Autoreset settings

3.5.12 Group 3.11: Timer functions

The functions of this parameter group can be made the fullest advantage of if the Real Time Clock settings have been properly made during the Startup Wizard (see page 2 and page 3).

You can program the up to five incidents to take place between set points of time (*Intervals*) and additionally three timer-based functions to last for a set period of time.

Intervals and Timers are assigned to the three available *Time Channels*.

Example of programming: You want to apply Preset frequency 1 (M3.3.11, set to use with parameter M3.5.1.15, Preset frequency selection 0) Mondays, from 08:00 until 16:00 hrs .

1. Set the parameters for Interval 1 (3.11.1):

M3.11.1.3: From day: '1' (=Monday)

M3.11.1.1: ON time: '0800'

M3.11.1.2: OFF time: '1600'

M3.11.1.4: To day: '1' (=Monday)

M3.11.1.5: Assign to channel: '1' (= Time Channel 1)

2. Then assign the selected Time channel to a digital input using the TTF method, (see chapter 3.5.2).

Go to menu *Parameters* (M3), further down to menu *I/O config* (M3.5) and *Digital inputs* (M3.5.1). Locate the parameter *Preset frequency selection 0* (M3.5.1.15). Change the value of this parameter to *TimeChannel.1*.

Now the function *Preset frequency selection 0* is activated at 08:00 on Monday and deactivated at 16:00 the same day.

The status of the Intervals and Time channels can be monitored in Menu M2.3.

Code	Parameter	Min	Max	Unit	Default	ID	Description
3.11.1 INTERVAL 1							
M3.11.1.1	ON time	00:00:00	23:59:59	hh:mm:ss	00:00:00	1464	ON time
M3.11.1.2	OFF time	00:00:00	23:59:59	hh:mm:ss	00:00:00	1465	OFF time
M3.11.1.3	From day	0	6		0	1466	ON day of week 0=Sunday 1=Monday 2=Tuesday 3=Wednesday 4=Thursday 5=Friday 6=Saturday
M3.11.1.4	To day	0	6		0	1467	See above
M3.11.1.5	Assign to channel	0	3		0	1468	Select affected time channel (1-3) 0=Not used 1=Time channel 1 2=Time channel 2 3=Time channel 3
3.11.2 INTERVAL 2							
M3.11.2.1	ON time	00:00:00	23:59:59	hh:mm:ss	00:00:00	1469	See Interval 1
M3.11.2.2	OFF time	00:00:00	23:59:59	hh:mm:ss	00:00:00	1470	See Interval 1
M3.11.2.3	From day	0	6		0	1471	See Interval 1

M3.11.2.4	To day	0	6		0	1472	See Interval 1
M3.11.2.5	Assign to channel	0	3		0	1473	See Interval 1
3.11.3 INTERVAL 3							
M3.11.3.1	ON time	00:00:00	23:59:59	hh:mm:ss	00:00:00	1474	See Interval 1
M3.11.3.2	OFF time	00:00:00	23:59:59	hh:mm:ss	00:00:00	1475	See Interval 1
M3.11.3.3	From day	0	6		0	1476	See Interval 1
M3.11.3.4	To day	0	6		0	1477	See Interval 1
M3.11.3.5	Assign to channel	0	3		0	1478	See Interval 1
3.11.4 INTERVAL 4							
M3.11.4.1	ON time	00:00:00	23:59:59	hh:mm:ss	00:00:00	1479	See Interval 1
M3.11.4.2	OFF time	00:00:00	23:59:59	hh:mm:ss	00:00:00	1480	See Interval 1
M3.11.4.3	From day	0	6		0	1481	See Interval 1
M3.11.4.4	To day	0	6		0	1482	See Interval 1
M3.11.4.5	Assign to channel	0	3		0	1483	See Interval 1
3.11.5 INTERVAL 5							
M3.11.5.1	ON time	00:00:00	23:59:59	hh:mm:ss	00:00:00	1484	See Interval 1
M3.11.5.2	OFF time	00:00:00	23:59:59	hh:mm:ss	00:00:00	1485	See Interval 1
M3.11.5.3	From day	0	6		0	1486	See Interval 1
M3.11.5.4	To day	0	6		0	1487	See Interval 1
M3.11.5.5	Assign to channel	0	3		0	1488	See Interval 1
3.11.6 TIMER 1							
M3.11.6.1	Duration	0	72000	s	0	1489	The time the timer will run when activated. (Activated by DI)
M3.11.6.2	Assign to channel	0	3		0	1490	Select affected time channel (1-3) 0=Not used 1=Time channel 1 2=Time channel 2 3=Time channel 3
3.11.7 TIMER 2							
M3.11.7.1	Duration	0	72000	s	0	1491	See Timer 1
M3.11.7.2	Assign to channel	0	3		0	1492	See Timer 1
3.11.8 TIMER 3							
M3.11.8.1	Duration	0	72000	s	0	1493	See Timer 1
M3.11.8.2	Assign to channel	0	3		0	1494	See Timer 1

Table 37. Timer functions

3.5.13 Group 3.12: PID-controller 1

3.5.13.1 *Basic settings*

Code	Parameter	Min	Max	Unit	Default	ID	Description
M3.12.1.1	PID gain	0.00	1000.00	%	100.00	118	If the value of the parameter is set to 100% a change of 10% in the error value causes the controller output to change by 10%.
M3.12.1.2	PID integration time	0.00	600.00	s	1.00	119	If this parameter is set to 1,00 second a change of 10% in the error value causes the controller output to change by 10.00%/s.
M3.12.1.3	PID derivation time	0.00	100.00	s	0.00	132	If this parameter is set to 1,00 second a change of 10% in the error value during 1.00 s causes the controller output to change by 10.00%.
M3.12.1.4	Process unit selection	1	40		1	1036	Select unit for actual value.
M3.12.1.5	Process unit min	Varies	Varies	Varies	0	1033	
M3.12.1.6	Process unit max	Varies	Varies	Varies	100	1034	
M3.12.1.7	Process unit decimals	0	4		2	1035	Number of decimals for process unit value
M3.12.1.8	Error inversion	0	1		0	340	0 = Normal (Feedback < Setpoint -> Increase PID output) 1 = Inverted (Feedback < Setpoint -> Decrease PID output)
M3.12.1.9	Dead band hysteresis	Varies	Varies	Varies	0	1056	Dead band area around the setpoint in process units. The PID output is locked if the feedback stays within the deadband area for a pre-defined time.
M3.12.1.10	Dead band delay	0.00	320.00	s	0.00	1057	If the feedback stays within the dead band area for a pre-defined time, the output is locked.

Table 38.

3.5.13.2 *Setpoints*

Code	Parameter	Min	Max	Unit	Default	ID	Description
M3.12.2.1	Keypad setpoint 1	Varies	Varies	Varies	0	167	
M3.12.2.2	Keypad setpoint 2	Varies	Varies	Varies	0	168	
M3.12.2.3	Setpoint ramp time	0.00	300.0	s	0.00	1068	Defines the rising and falling ramp times for setpoint changes. (Time to change from minimum to maximum)
M3.12.2.4	Setpoint source 1 selection	0	16		1	332	0 = Not used 1 = Keypad setpoint 1 2 = Keypad setpoint 2 3 = AI1 4 = AI2 5 = AI3 6 = AI4 7 = AI5 8 = AI6 9 = ProcessDataIn1 10 = ProcessDataIn2 11 = ProcessDataIn3 12 = ProcessDataIn4 13 = ProcessDataIn5 14 = ProcessDataIn6 15 = ProcessDataIn7 16 = ProcessDataIn8 AI's and ProcessDataIn are handled as percent (0.00-100.00%) and scaled according to Setpoint minimum and maximum. NOTE: ProcessDataIn use two decimals.
M3.12.2.5	Setpoint 1 minimum	-200.00	200.00	%	0.00	1069	Minimum value at analog signal minimum.
M3.12.2.6	Setpoint 1 maximum	-200.00	200.00	%	100.00	1070	Maximum value at analog signal maximum.
 M3.12.2.7	Sleep frequency limit 1	0.00	320.00	Hz	0.00	1016	Drive goes to sleep mode when the output frequency stays below this limit for a time greater than that defined by parameter <i>Sleep delay</i> .
 M3.12.2.8	Sleep delay 1	0	3000	s	0	1017	The minimum amount of time the frequency has to remain below the Sleep level before the drive is stopped.
 M3.12.2.9	Wake-up level 1			Varies	0.0000	1018	Defines the level for the PID feedback value wake-up supervision. Uses selected process units.
M3.12.2.10	Setpoint 1 boost	-2.0	2.0	x	1.0	1071	The setpoint can be boosted with a digital input.
M3.12.2.11	Setpoint source 2 selection	0	16		2	431	See par. M3.12.2.4
M3.12.2.12	Setpoint 2 minimum	-200.00	200.00	%	0.00	1073	Minimum value at analog signal minimum.

M3.12.2.13	Setpoint 2 maximum	-200.00	200.00	%	100.00	1074	Maximum value at analog signal maximum.
M3.12.2.14	Sleep frequency limit 2	0.00	320.00	Hz	0.00	1075	See M3.12.2.7.
M3.12.2.15	Sleep delay 2	0	3000	s	0	1076	See M3.12.2.8.
M3.12.2.16	Wake-up level 2			Varies	0.0000	1077	See M3.12.2.9.
M3.12.2.17	Setpoint 2 boost	-2.0	2.0	x	1.0	1078	See M3.12.2.10.

Table 39.

3.5.13.3 Feedbacks

Code	Parameter	Min	Max	Unit	Default	ID	Description
M3.12.3.1	Feedback function	1	9		1	333	1=Only Source1 in use 2=SQRT(Source1);(Flow=Constant x SQRT(Pressure)) 3=SQRT(Source1- Source 2) 4=SQRT(Source 1) + SQRT (Source 2) 5=Source 1 + Source 2 6=Source 1 - Source 2 7=MIN (Source 1, Source 2) 8=MAX (Source 1, Source 2) 9=MEAN (Source1, Source2)
M3.12.3.2	Feedback function gain	-1000.0	1000.0	%	100.0	1058	Used e.g. with selection 2 in <i>Feedback function</i>
M3.12.3.3	Feedback 1 source selection	0	14		2	334	0 = Not used 1 = AI1 2 = AI2 3 = AI3 4 = AI4 5 = AI5 6 = AI6 7 = ProcessDataIn1 8 = ProcessDataIn2 9 = ProcessDataIn3 10 = ProcessDataIn4 11 = ProcessDataIn5 12 = ProcessDataIn6 13 = ProcessDataIn7 14 = ProcessDataIn8 AI's and ProcessDataIn are handled as % (0.00-100.00%) and scaled according to Feedback min and max. NOTE: ProcessDataIn use two decimals.
M3.12.3.4	Feedback 1 minimum	-200.00	200.00	%	0.00	336	Minimum value at analog signal minimum.
M3.12.3.5	Feedback 1 maximum	-200.00	200.00	%	100.00	337	Maximum value at analog signal maximum.
M3.12.3.6	Feedback 2 source selection	0	14		0	335	See M3.12.3.3
M3.12.3.7	Feedback 2 minimum	-200.00	200.00	%	0.00	338	Minimum value at analog signal minimum.
M3.12.3.8	Feedback 2 maximum	-200.00	200.00	%	100.00	339	Maximum value at analog signal maximum.

Table 40.

3.5.13.4 Feedforward

Feedforward usually needs accurate process models, but in some simple cases a gain + offset type of feedforward is enough. The feedforward part does not use any feedback measurements of the actual controlled process value (water level in the example on page 76). Feedforward control uses other measurements which are indirectly affecting the controlled process value.



Code	Parameter	Min	Max	Unit	Default	ID	Description
M3.12.4.1	Feedforward function	1	9		1	1059	See M3.12.3.1.
M3.12.4.2	Feedforward function gain	-1000	1000	%	100.0	1060	See M3.12.3.2
M3.12.4.3	Feedforward 1 source selection	0	14		0	1061	See M3.12.3.3
M3.12.4.4	Feedforward 1 minimum	-200.00	200.00	%	0.00	1062	See M3.12.3.4
M3.12.4.5	Feedforward 1 maximum	-200.00	200.00	%	100.00	1063	See M3.12.3.5
M3.12.4.6	Feedforward 2 source selection	0	14		0	1064	See M3.12.3.6
M3.12.4.7	Feedforward 2 min	-200.00	200.00	%	0.00	1065	See M3.12.3.7
M3.12.4.8	Feedforward 2 max	-200.00	200.00	%	100.00	1066	See M3.12.3.8

Table 41.

3.5.13.5 Process supervision

Process supervision is used to control that the actual value stays within predefined limits. With this function you can e.g. detect a major pipe burst and stop unnecessary flooding. See more on page 77.



Code	Parameter	Min	Max	Unit	Default	ID	Description
M3.12.5.1	Enable process supervision	0	1		0	735	0 = Disabled 1 = Enabled
M3.12.5.2	Upper limit	Varies	Varies	Varies	Varies	736	Upper actual/process value supervision
M3.12.5.3	Lower limit	Varies	Varies	Varies	Varies	758	Lower actual/process value supervision
M3.12.5.4	Delay	0	30000	s	0	737	If the desired value is not reached within this time a fault or alarm is created.

Table 42.

3.5.13.6 Pressure loss compensation

Code	Parameter	Min	Max	Unit	Default	ID	Description
M3.12.6.1	Enable setpoint 1	0	1		0	1189	Enables pressure loss compensation for setpoint 1. 0 = Disabled 1 = Enabled
M3.12.6.2	Setpoint 1 max compensation	Varies	Varies	Varies	Varies	1190	Value added proportionally to the frequency. Setpoint compensation = Max compensation * (FreqOut-MinFreq)/(Max-Freq-MinFreq)
M3.12.6.3	Enable setpoint 2	0	1		0	1191	See M3.12.6.1.
M3.12.6.4	Setpoint 2 max compensation	Varies	Varies	Varies	Varies	1192	See M3.12.6.2.

Table 43.

3.5.13.7 PID1 Soft Fill

The Soft Fill function is used, for example, to avoid pressure pikes, the so-called "water hammers" in pipes when the drive starts to regulate. If not controlled, these pikes might lead to damaged pipes. See more information on page 80.

Code	Parameter	Min	Max	Unit	Default	ID	Description
M3.12.7.1	Enable soft fill	0	1		0	1094	0=Disable 1=Enable
M3.12.7.2	Soft fill frequency	M3.3.1	M3.3.2	Hz	0.00	1055	The drive accelerates to this frequency before starting to control.
M3.12.7.3	Soft fill level	0	Varies	Varies	0.0000	1095	The drive runs at the Soft Fill frequency until the feedback reaches this value. When reached, the controller starts to regulate.
M3.12.7.4	Soft fill timeout	0	30000	s	0	1096	If the desired value is not reached within this time, fault or alarm is triggered (leaking pipe alarm). 0=No timeout used

Table 44. PID1 Soft fill parameters

3.5.14 Group 3.13: PID-controller 2

3.5.14.1 Basic settings

For more detailed information, see chapter 3.5.13.

Code	Parameter	Min	Max	Unit	Default	ID	Description
M3.13.1.1	Enable PID	0	1		0	1630	0 = Disabled 1 = Enabled
M3.13.1.2	Output in Stop	0.0	100.0	%	0.0	1100	The output value of the PID controller in % of its maximum output value while it is stopped from digital input
M3.13.1.3	PID gain	0.00	1000.00	%	100.00	1631	
M3.13.1.4	PID integration time	0.00	600.00	s	1.00	1632	
M3.13.1.5	PID derivation time	0.00	100.00	s	0.00	1633	
M3.13.1.6	Process unit selection	0	40		1	1635	
M3.13.1.7	Process unit min	Varies	Varies	Varies	0	1664	
M3.13.1.8	Process unit max	Varies	Varies	Varies	100	1665	
M3.13.1.9	Process unit decimals	0	4		2	1666	
M3.13.1.10	Error inversion	0	1		0	1636	
M3.13.1.11	Dead band hysteresis	Varies	Varies	Varies	0.0	1637	
M3.13.1.12	Dead band delay	0.00	320.00	s	0.00	1638	

Table 45.

3.5.14.2 Setpoints

Code	Parameter	Min	Max	Unit	Default	ID	Description
M3.13.2.1	Keypad setpoint 1	0.00	100.00	Varies	0.00	1640	
M3.13.2.2	Keypad setpoint 2	0.00	100.00	Varies	0.00	1641	
M3.13.2.3	Setpoint ramp time	0.00	300.00	s	0.00	1642	
M3.13.2.4	Setpoint source 1 selection	0	16		1	1643	
M3.13.2.5	Setpoint 1 minimum	-200.00	200.00	%	0.00	1644	Minimum value at analog signal minimum.
M3.13.2.6	Setpoint 1 maximum	-200.00	200.00	%	100.00	1645	Maximum value at analog signal maximum.
M3.13.2.7	Setpoint source 2 selection	0	16		0	1646	See M3.13.2.4.
M3.13.2.8	Setpoint 2 minimum	-200.00	200.00	%	0.00	1647	Minimum value at analog signal minimum.
M3.13.2.9	Setpoint 2 maximum	-200.00	200.00	%	100.00	1648	Maximum value at analog signal maximum.

Table 46.

3.5.14.3 Feedback

For more detailed information, see chapter 3.5.13.

Code	Parameter	Min	Max	Unit	Default	ID	Description
M3.13.3.1	Feedback function	1	9		1	1650	
M3.13.3.2	Feedback function gain	-1000.0	1000.0	%	100.0	1651	
M3.13.3.3	Feedback 1 source selection	0	14		1	1652	
M3.13.3.4	Feedback 1 minimum	-200.00	200.00	%	0.00	1653	Minimum value at analog signal minimum.
M3.13.3.5	Feedback 1 maximum	-200.00	200.00	%	100.00	1654	Maximum value at analog signal maximum.
M3.13.3.6	Feedback 2 source selection	0	14		2	1655	
M3.13.3.7	Feedback 2 minimum	-200.00	200.00	%	0.00	1656	Minimum value at analog signal minimum.
M3.13.3.8	Feedback 2 maximum	-200.00	200.00	%	100.00	1657	Maximum value at analog signal maximum.

Table 47.

3.5.14.4 Process supervision

For more detailed information, see chapter 3.5.13.

Code	Parameter	Min	Max	Unit	Default	ID	Description
M3.13.4.1	Enable supervision	0	1		0	1659	0 = Disabled 1 = Enabled
M3.13.4.2	Upper limit	Varies	Varies	Varies	Varies	1660	
M3.13.4.3	Lower limit	Varies	Varies	Varies	Varies	1661	
M3.13.4.4	Delay	0	30000	s	0	1662	If the desired value is not reached within this time a fault or alarm is activated.

Table 48.

3.5.15 Group 3.14: Pump and Fan Cascade

The *Multi-pump* functionality allows you to control **up to 4 motors** (pumps, fans) with PID controller 1. The drive is connected to one motor which is the "regulating" motor connecting and disconnecting the other motors to/from the mains, by means of contactors controlled with relays when needed in order to maintain the right setpoint. The *Autochange* function controls the order/priority in which the motors are started in order to guarantee their equal wear. The controlling motor **can be included** in the autochange and interlocks logic, or, it may be selected to always functions as Motor 1. Motors can be taken out of use momentarily, e.g. for service, using the motor *Interlock function*. See page 81.

Code	Parameter	Min	Max	Unit	Default	ID	Description
M3.14.1	Number of motors	1	4		1	1001	Total number of motors (pumps/fans) used in multi-pump system
M3.14.2	Interlock function	0	1		1	1032	Enable/Disable use of interlocks. Interlocks are used to tell the system if a motor is connected or not. 0 = Disabled 1 = Enabled
M3.14.3	Include FC	0	1		1	1028	Include the drive in the autochange and interlocking system. 0 = Disabled 1 = Enabled
M3.14.4	Autochange	0	1		0	1027	Disable/enable rotation of starting order and priority of motors. 0 = Disabled 1 = Enabled
M3.14.5	Autochange interval	0.0	3000.0	h	48.0	1029	After the expiry of the time defined with this parameter, the autochange function takes place if the capacity used lies below the level defined with parameters M3.14.6 and M3.14.7.
M3.14.6	Autochange: Frequency limit	0.00	50.00	Hz	25.00	1031	These parameters define the level below which the capacity used must remain so that the autochange can take place.
M3.14.7	Autochange: Motor limit	0	4		1	1030	
M3.14.8	Bandwidth	0	100	%	10	1097	Percentage of the setpoint. E.g.: Setpoint = 5 bar, Bandwidth = 10%: As long as the feedback value stays within 4.5...5.5 bar motor disconnection or removal will not take place.
M3.14.9	Bandwidth delay	0	3600	s	10	1098	With feedback outside the bandwidth, this time must pass before pumps are added or removed.

Table 49. Multi-pump parameters

3.5.16 Group 3.15: Maintenance counters

Three maintenance counters can be programmed and given alarm and fault levels independently. The alarm or fault level, or both, can be used.

There are two modes (hours or revolutions). Revolutions are estimated by integrating the Motor Speed every second and shown in 1000 revolutions on the keypad.

When one of the limits is reached a warning or a fault is triggered and shown on the panel. It is also possible to send information to a relay that a warning or fault limit has been reached. Timers are also independently resettable with the reset parameter or a digital input.

Code	Parameter	Min	Max	Unit	Default	ID	Description
M3.15.1	Counter 1 mode	0	2		0	1104	0 = Not used 1 = Hours 2 = Revs*1000
M3.15.2	Counter 1 alarm limit	0	80000	h/revs	0	1105	Defines when to trig a maintenance alarm for Counter 1. 0 = Not used
M3.15.3	Counter 1 fault limit	0	80000	h/revs	0	1106	Defines when to trig a maintenance fault for Counter 1. 0 = Not used
M3.15.4	Counter 1 reset	0	1		0	1107	Changing parameter value from 0 to 1 resets counter.
M3.15.5	Counter 2 mode	0	2		0	1108	0 = Not used 1 = Hours 2 = Revs*1000
M3.15.6	Counter 2 alarm limit	0	80000	h/revs	0	1109	Defines when to trig a maintenance alarm for Counter 2. 0 = Not used
M3.15.7	Counter 2 fault limit	0	80000	h/revs	0	1110	Defines when to trig a maintenance fault for Counter 2. 0 = Not used
M3.15.8	Counter 2 reset	0	1		0	1111	Changing parameter value from 0 to 1 resets counter.
M3.15.9	Counter 3 mode	0	2		0	1163	0 = Not used 1 = Hours 2 = Revs*1000
M3.15.10	Counter 3 alarm limit	0	80000	h/revs	0	1164	Defines when to trig a maintenance alarm for Counter 3. 0 = Not used
M3.15.11	Counter 3 fault limit	0	80000	h/revs	0	1165	Defines when to trig a maintenance fault for Counter 3. 0 = Not used
M3.15.12	Counter 3 reset	0	1		0	1166	Changing parameter value from 0 to 1 resets counter.

Table 50. Maintenance counter parameters

3.5.17 Group 3.15: Fire mode

Drive ignores all commands from keypad, fieldbuses and PC tool and runs at preset frequency when activated. If activated, alarm sign is shown on the keypad and **warranty is void**. In order to enable the function, you need to set a password in the description field for parameter *Fire Mode password*.

NOTE! THE WARRANTY IS VOID IF THIS FUNCTION IS ACTIVATED! There is also a different password for test mode to be used for testing the Fire Mode without the warranty becoming void.

Code	Parameter	Min	Max	Unit	Default	ID	Description
M3.16.1	Fire Mode password	0	9999		0	1599	1001 = Enabled 1234 = Test mode
M3.16.2	Fire Mode activation				DigIN Slot0.2	1596	FALSE = Fire Mode active TRUE = No action
M3.16.3	Fire Mode frequency	0	M3.3.2	Hz	0.00	1598	Frequency used when Fire Mode is activated.
M3.16.4	Fire Mode status	0	3		0	1597	Monitoring value (see also Table 14) 0=Disabled 1=Enabled 2=Activated (Enabled + DI Open) 3=Test Mode

Table 51. Fire mode parameters

3.6 HVAC Application - Additional parameter information

Due to its user-friendliness and simplicity of use, the most parameters of the HVAC Application only require a basic description which is given in the parameter tables in chapter 3.5.

In this chapter, you will find additional information on certain most advanced parameters of the HVAC Application. Should you not find the information you need contact your distributor.

M3.1.1.7 **MOTOR CURRENT LIMIT**

This parameter determines the maximum motor current from the drive. The parameter value range differs from size to size.

When the current limit is active the drive output frequency is decreased.

NOTE: This is not an overcurrent trip limit.

M3.2.5 **STOP FUNCTION**

Selection number	Selection name	Description
0	Coasting	The motor is allowed to stop on its own inertia. The control by the drive is discontinued and the drive current drops to zero as soon as the stop command is given.
1	Ramp	After the Stop command, the speed of the motor is decelerated according to the set deceleration parameters to zero speed.

M3.2.6 **I/O A START/STOP LOGIC**

Values 0...2 offer possibilities to control the starting and stopping of the drive with digital signal connected to digital inputs. CS = Control signal.

Selection number	Selection name	Note
0	Start forward	The functions take place when the contacts are closed.
1	CS1: Start fwd pulse CS2: Stop pulse	For 3-wire control (pulse control) See Figure 8.
2	Start fwd pulse	Required to start.
3	AI1 threshold	The motor will start at the level set with parameter this parameter and stop at the same -2% AI1 can also be used as frequency reference in parallel.

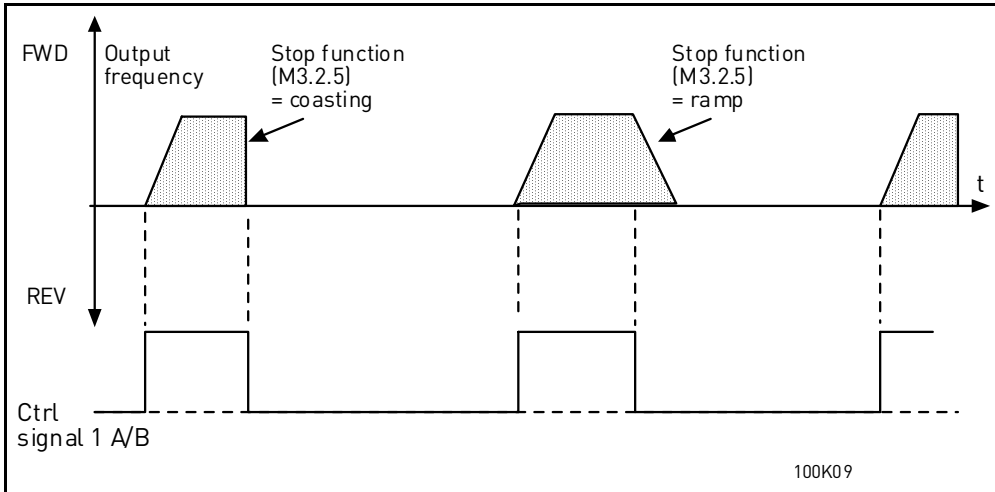

Figure 7. Start forward

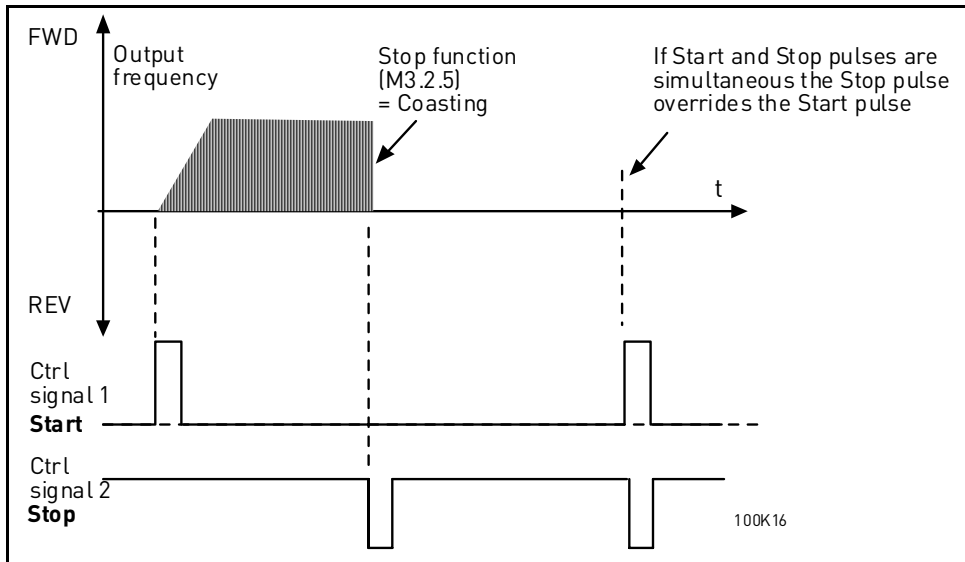

Figure 8. Start pulse/ Stop pulse

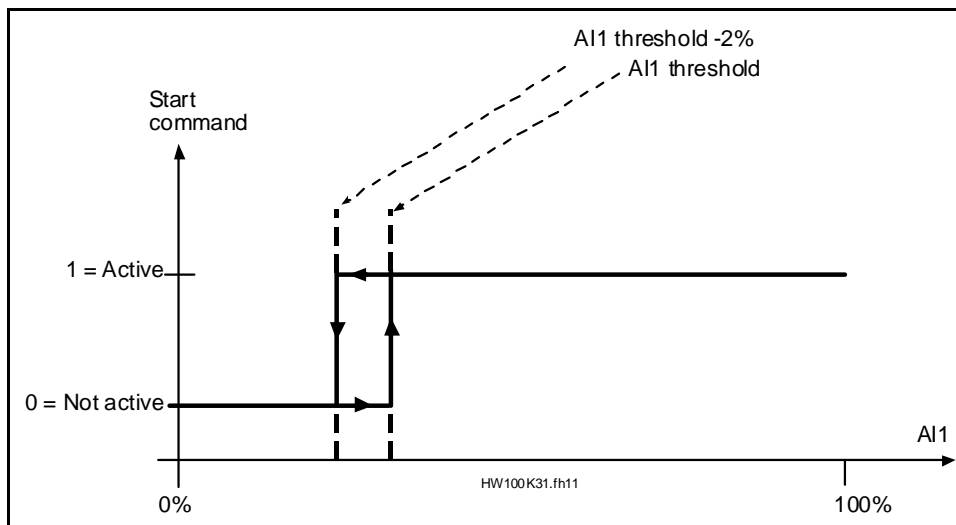

Figure 9. AI1 threshold

M3.2.10 KEYPAD MASTER STOP

The AC drive can be forced to stop state from keypad stop button even if it is controlled from another control place (*Remote*). If this measure is taken, the drive goes to the alarm state and cannot be restarted from the remote control place before the start button has been pressed (while in *Remote*).

You can still momentarily switch to *Local* and start there but when going back to *Remote* a start button press is needed. This also applies after a power-down as the state of this function is retained in memory.

The function can be enabled or disabled with this parameter.

M3.3.9 PRESET FREQUENCY MODE

You can use the preset frequency parameters to define certain frequency references in advance. These references are then applied by activating/inactivating digital inputs connected to parameters M3.5.1.16, M3.5.1.17 and M3.5.1.18 (*Preset frequency selection 0, Preset frequency selection 1 and Preset frequency selection 2*). Two different logics can be selected:

Selection number	Selection name	Note
0	Binary coded	Combine activated inputs according to Table 52 to choose the Preset frequency needed.
1	Number (of inputs used)	According to how many of the inputs assigned for <i>Preset frequency selections</i> are active you can apply the <i>Preset frequencies</i> 1 to 3.

M3.3.10 TO M3.3.17 PRESET FREQUENCIES 1 TO 7

The values of the preset frequencies are automatically limited between the minimum and maximum frequencies (M3.3.1 and M3.3.2). See table below.

Required action			Activated frequency
Choose value 1 for parameter M3.3.3			Preset frequency 0
B2	B1	B0	Preset frequency 1
B2	B1	B0	Preset frequency 2
B2	B1	B0	Preset frequency 3
B2	B1	B0	Preset frequency 4
B2	B1	B0	Preset frequency 5
B2	B1	B0	Preset frequency 6
B2	B1	B0	Preset frequency 7

Table 52. Selection of preset frequencies; ■ = input activated

M3.4.1 RAMP 1 SHAPE

The start and end of acceleration and deceleration ramps can be smoothed with this parameter. Setting value 0 gives a linear ramp shape which causes acceleration and deceleration to act immediately to the changes in the reference signal.

Setting value 0.1...10 seconds for this parameter produces an S-shaped acceleration/deceleration. The acceleration time is determined with parameters M3.4.2 and M3.4.3. See Figure 10. These parameters are used to reduce mechanical erosion and current spikes when the reference is changed.

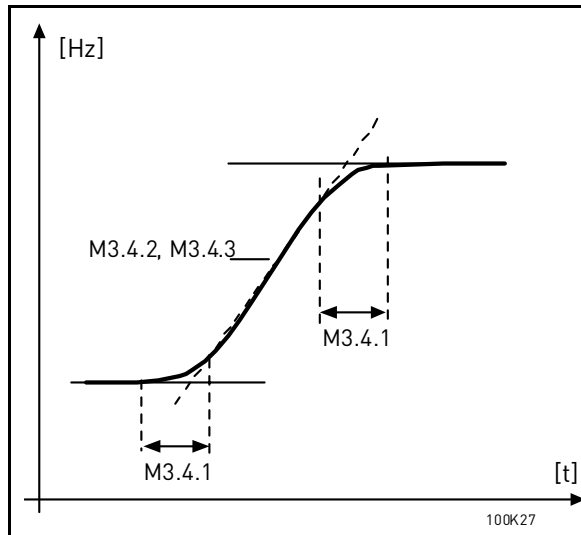

Figure 10. Acceleration/Deceleration (S-shaped)

M3.4.8 RAMP TIME OPTIMIZER

If the ramp time optimizer is enabled the deceleration time will be increased by the percentage defined in parameter M3.4.9 *Ramp optimizing percentage* every time we hit the overvoltage controller during deceleration or acceleration time when hitting the current limit during acceleration. There is also a parameter for setting a max limit for the ramp (M3.4.10). The ramp optimizer will not stretch the ramps above this limit.

NOTE: The ramp time optimizer only affects the settings of Ramp 1. Ramp 2 will not be modified.

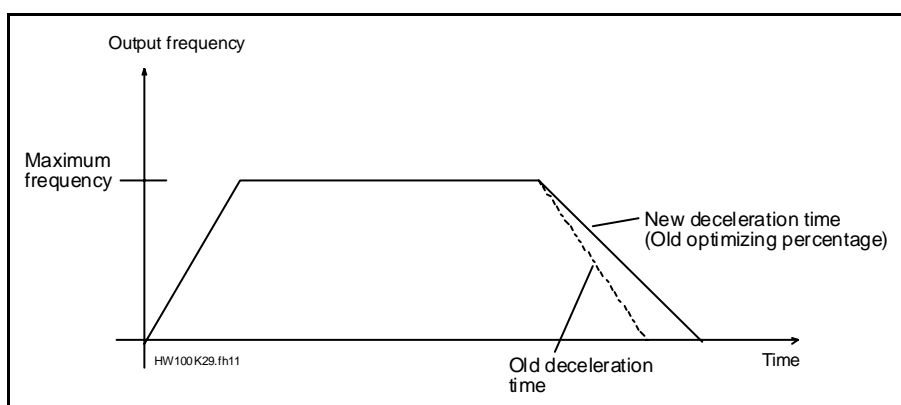

Figure 11.

M3.4.16 FLUX BRAKING

Instead of DC braking, flux braking is a useful way to raise the braking capacity in cases where additional brake resistors are not needed.

When braking is needed, the frequency is reduced and the flux in the motor is increased, which in turn increases the motor's capability to brake. Unlike DC braking, the motor speed remains controlled during braking.

The flux braking can be set ON or OFF.

NOTE: Flux braking converts the energy into heat at the motor, and should be used intermittently to avoid motor damage.

M3.5.1.10 ***RUN ENABLE***

Contact open: Start of motor **disabled**

Contact closed: Start of motor **enabled**

The drive is stopped according to the selected function at M3.2.5. The follower drive will always coast to stop.

M3.5.1.11 ***RUN INTERLOCK 1***

M3.5.1.12 ***RUN INTERLOCK 2***

The drive cannot be started if any of the interlocks are open.

The function could be used for a damper interlock, preventing the drive to start with damper closed.

M3.5.1.16 ***PRESET FREQUENCY SELECTION 0***

M3.5.1.17 ***PRESET FREQUENCY SELECTION 1***

M3.5.1.18 ***PRESET FREQUENCY SELECTION 2***

Connect a digital input to these functions with the TTF programming method (see chapter 3.5.2) to be able to apply Preset frequencies 1 to 7 (see Table 52 and pages 37, 40 and 66).

M3.5.2.2 AI1 SIGNAL FILTER TIME

When this parameter is given a value greater than 0 the function that filters out disturbances from the incoming analog signal is activated.

NOTE: Long filtering time makes the regulation response slower!

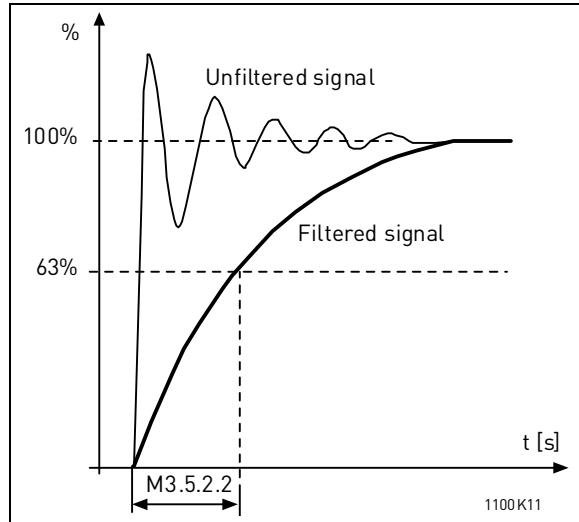

Figure 12. AI1 signal filtering

M3.5.3.2.1 BASIC RO1 FUNCTION

Selection	Selection name	Description
0	Not used	
1	Ready	The drive is ready to operate
2	Run	The drive operates (motor is running)
3	General fault	A fault trip has occurred
4	General fault inverted	A fault trip has not occurred
5	General alarm	
6	Reversed	The reverse command has been selected
7	At speed	The output frequency has reached the set reference
8	Motor regulator activated	One of the limit regulators (e.g. current limit, torque limit) is activated
9	Preset frequency active	The preset frequency has been selected with digital input
10	Keypad control active	Keypad control mode selected
11	I/O control B active	I/O control place B selected
12	Limit supervision 1	Activates if the signal value falls below or exceeds the set supervision limit (M3.8.3 or M3.8.7) depending on the selected function.
13	Limit supervision 2	
14	Start command active	Start command is active.
15	Reserved	
16	Fire mode ON	
17	RTC timer 1 control	Time channel 1 is used.

Selection	Selection name	Description
18	RTC timer 2 control	Time channel 2 is used.
19	RTC timer 3 control	Time channel 3 is used.
20	FB Control WordB.13	
21	FB Control WordB.14	
22	FB Control WordB.15	
23	PID1 in Sleep mode	
24	Reserved	
25	PID1 supervision limits	PID1 feedback value is beyond supervision limits.
26	PID2 supervision limits	PID2 feedback value is beyond supervision limits.
27	Motor 1 control	Contact control for <i>Multi-pump</i> function
28	Motor 2 control	Contact control for <i>Multi-pump</i> function
29	Motor 3 control	Contact control for <i>Multi-pump</i> function
30	Motor 4 control	Contact control for <i>Multi-pump</i> function
31	Reserved	(Always open)
32	Reserved	(Always open)
33	Reserved	(Always open)
34	Maintenance warning	
35	Maintenance fault	

Table 53. Output signals via RO1

M3.7.8 RESONANCE SWEEP ACC/DEC TIME

The anti-resonance function slowly sweeps through frequencies from MinFreq to MaxFreq and back to MinFreq with the ramp times set with this parameter. During this sweep, the user should press the OK-button every time passing a resonance range in order to tag where the range starts and ends.

If everything is fine the Prohibit frequency range parameters (in Prohibited Frequencies menu) are provided with right information. If there is a different amount of tags during ramp-up compared to ramp-down nothing will be done but an info message is shown. The same will happen if the bands are not reasonable.

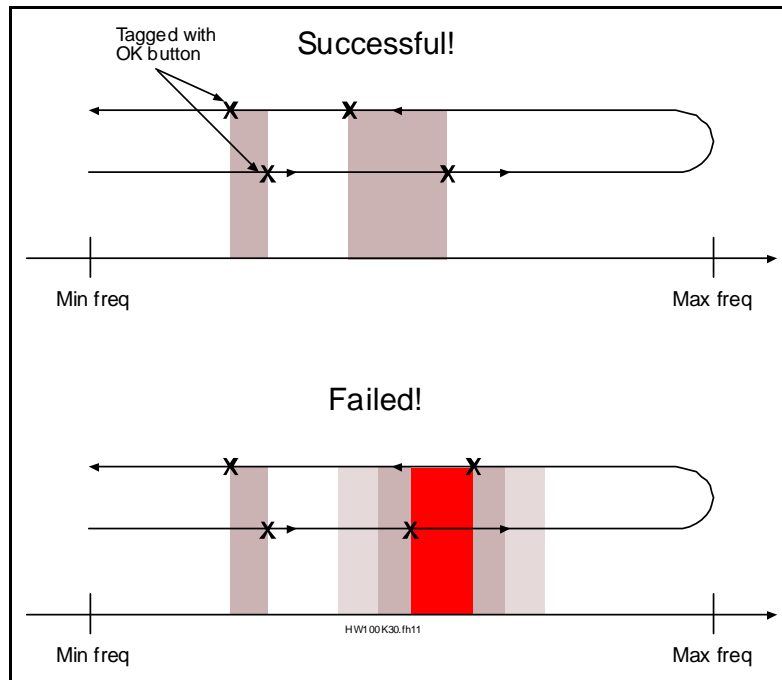

Figure 13.

M3.9.2 **RESPONSE TO EXTERNAL FAULT**

An alarm message or a fault action and message is generated by an external fault external fault signal in one of the programmable digital inputs (DI3 by default) using parameters M3.5.1.7 and M3.5.1.8. The information can also be programmed into any of the relay outputs.

M3.9.8 **MOTOR THERMAL ZERO SPEED COOLING**

Defines the cooling factor at zero speed in relation to the point where the motor is running at nominal speed without external cooling.

The default value is set assuming that there is no external fan cooling the motor. If an external fan is used this parameter can be set to 90% (or even higher).

If you change the parameter M3.1.1.4 (*Nominal current of motor*), this parameter is automatically restored to the default value.

Setting this parameter does not affect the maximum output current of the drive which is determined by parameter M3.1.1.7 alone.

The corner frequency for the thermal protection is 70% of the motor nominal frequency (M3.1.1.2).

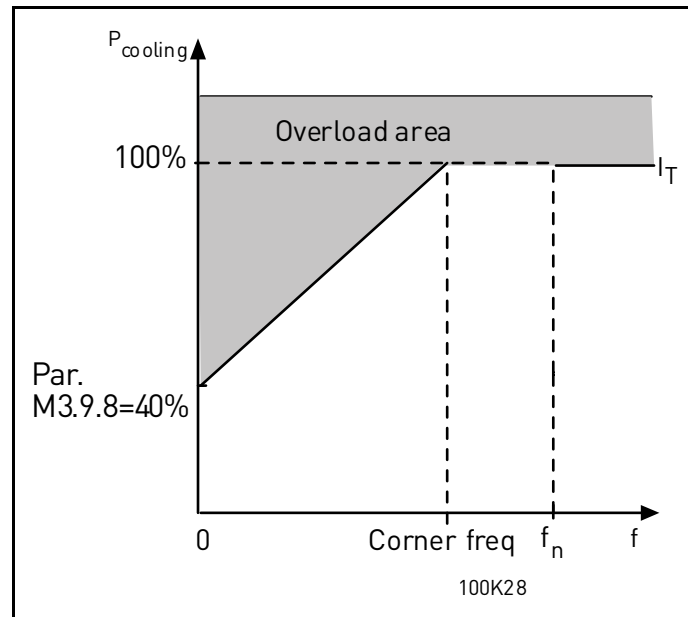

Figure 14. Motor thermal current I_T curve

M3.9.9 MOTOR THERMAL TIME CONSTANT

This is the thermal time constant of the motor. The bigger the motor, the bigger the time constant. The time constant is the time within which the calculated thermal stage has reached 63% of its final value.

The motor thermal time is specific to the motor design and it varies between different motor manufacturers. The default value of the parameter varies from size to size.

If the motor's t_6 -time (t_6 is the time in seconds the motor can safely operate at six times the rated current) is known (given by the motor manufacturer) the time constant parameter can be set basing on it. As a rule of thumb, the motor thermal time constant in minutes equals to $2 \cdot t_6$. If the drive is in stop stage the time constant is internally increased to three times the set parameter value. The cooling in stop stage is based on convection and the time constant is increased.

See Figure 15.

M3.9.10 MOTOR THERMAL LOADABILITY FACTOR

Setting value to 130% means that the nominal temperature will be reached with 130% of motor nominal current.

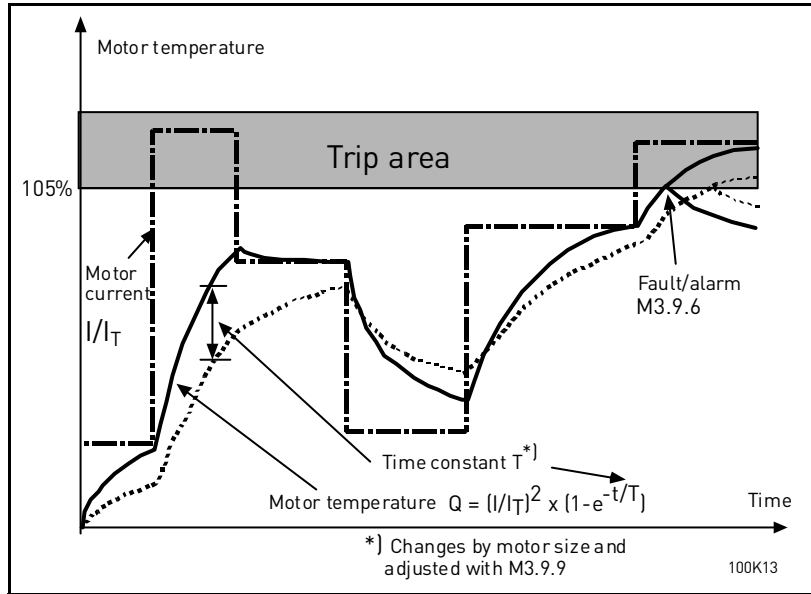

Figure 15. Motor temperature calculation

M3.10.1 **AUTOMATIC RESET**

Activate the *Automatic reset* after fault with this parameter.

NOTE: Automatic reset is allowed for certain faults only. By giving the parameters M3.10.6 to M3.10.13 the value **0** or **1** you can either allow or deny the automatic reset after the respective faults.

M3.10.4 AUTOMATIC RESET: TRIAL TIME

The Automatic reset function keeps resetting the faults appearing during the time set with this parameter. If the number of faults during the trial time exceed the value of parameter M3.10.5 a permanent fault is generated. Otherwise the fault is cleared after the trial time has elapsed and the next fault start the trial time count again.

Parameter M3.10.5 determines the maximum number of automatic fault reset attempts during the trial time set by this parameter. The time count starts from the first autoreset.

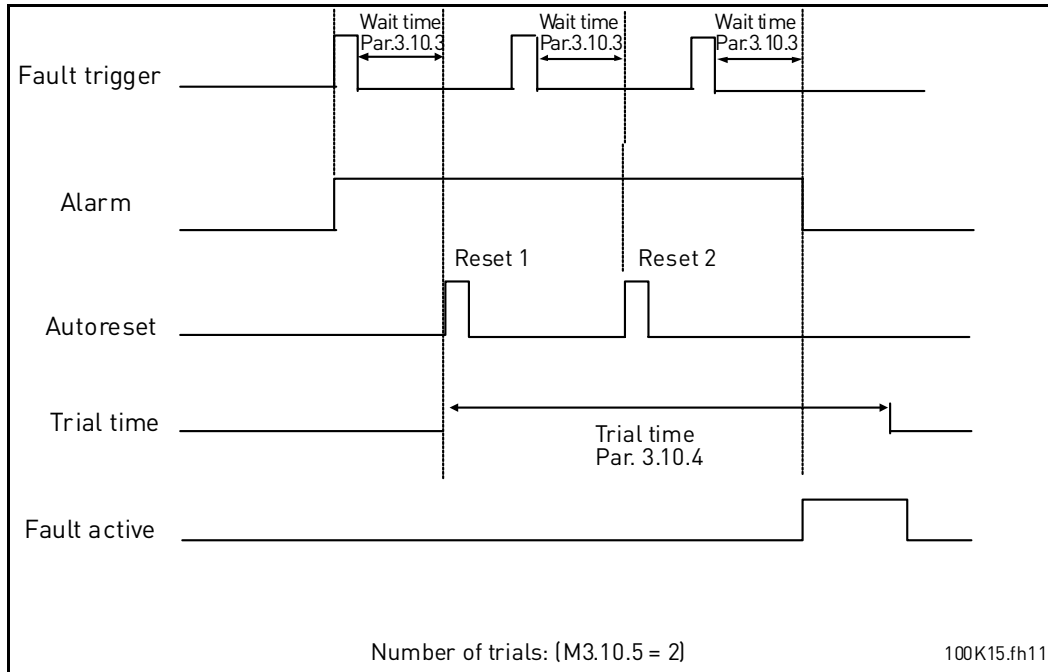

Figure 16. Automatic reset function

M3.12.1.9 **DEAD BAND HYSTERESIS**

M3.12.1.10 **DEAD BAND DELAY**

The PID controller output is locked if the actual value stays within the deadband area around the reference for a predefined time. This function will prevent unnecessary movement and wear on actuators, e.g. valves.

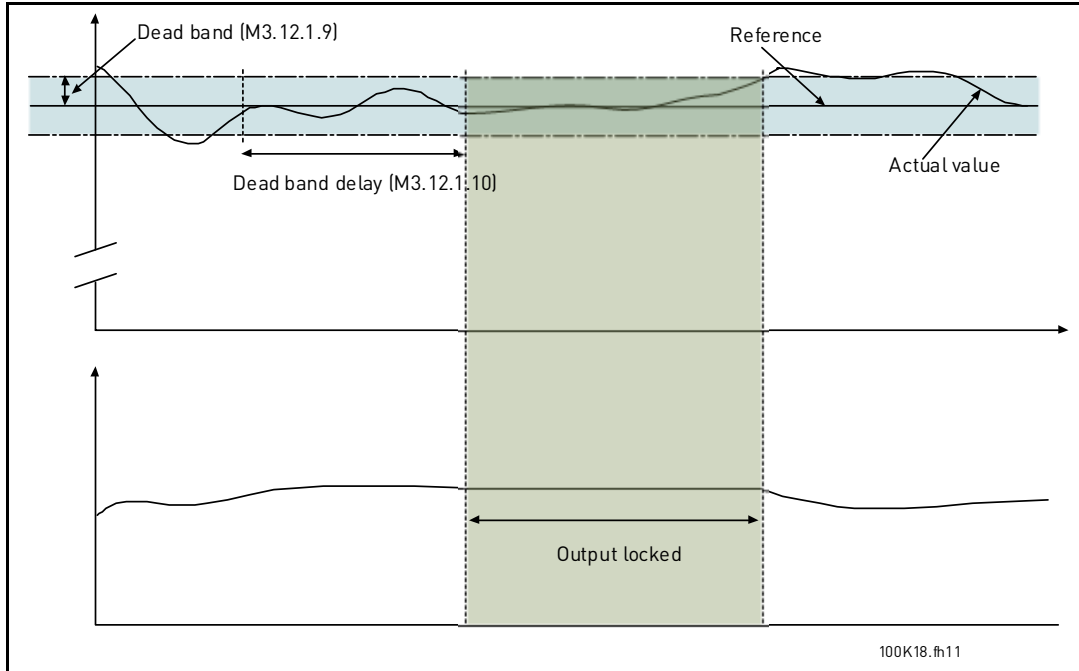

Figure 17. Dead band

M3.12.2.7 SLEEP FREQUENCY LIMIT 1**M3.12.2.8 SLEEP DELAY 1****M3.12.2.9 WAKE-UP LEVEL 1**

This function will put the drive into sleep mode if the frequency stays below the sleep limit for a longer time than that set with the Sleep Delay (M3.12.2.8). This means that the start command remains on, but the run request is turned off. When the actual value goes below, or above, the wake-up level depending on the set acting mode the drive will activate the run request again if the start command is still on.

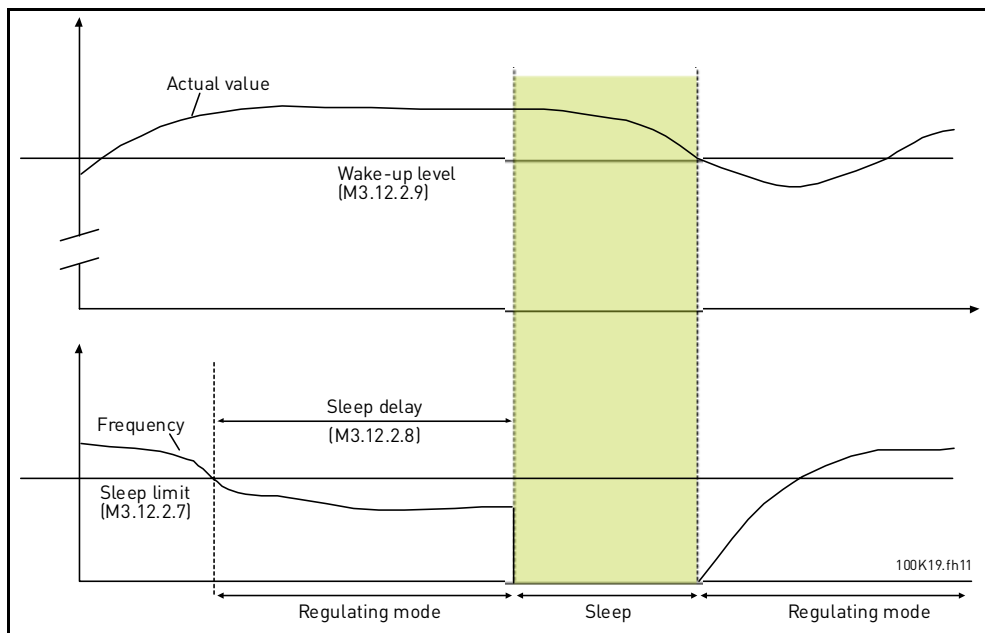

Figure 18. Sleep limit, Sleep delay, Wake-up level

M3.12.4.1 FEEDFORWARD FUNCTION

Feedforward usually needs accurate process models, but in some simple cases a gain + offset type of feedforward is enough. The feedforward part does not use any feedback measurements of the actual controlled process value (water level in the example on page 77). The feedforward control uses other measurements which are indirectly affecting the controlled process value.

Example 1:

Controlling the water level of a tank by means of flow control. The desired water level has been defined as a setpoint and the actual level as feedback. The control signal acts on the incoming flow.

The outflow could be thought of as a disturbance that can be measured. Based on the measurements of the disturbance, we can try to compensate for this disturbance by simple feedforward control (gain and offset) which is added to the PID output.

This way the controller would react much faster to changes in the outflow than if you just had measured the level.

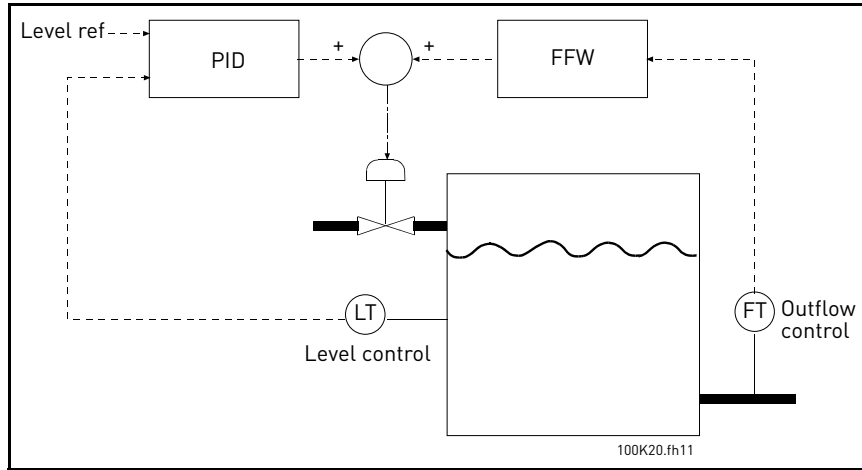

Figure 19. Feedforward control

M3.12.5.1 **ENABLE PROCESS SUPERVISION**

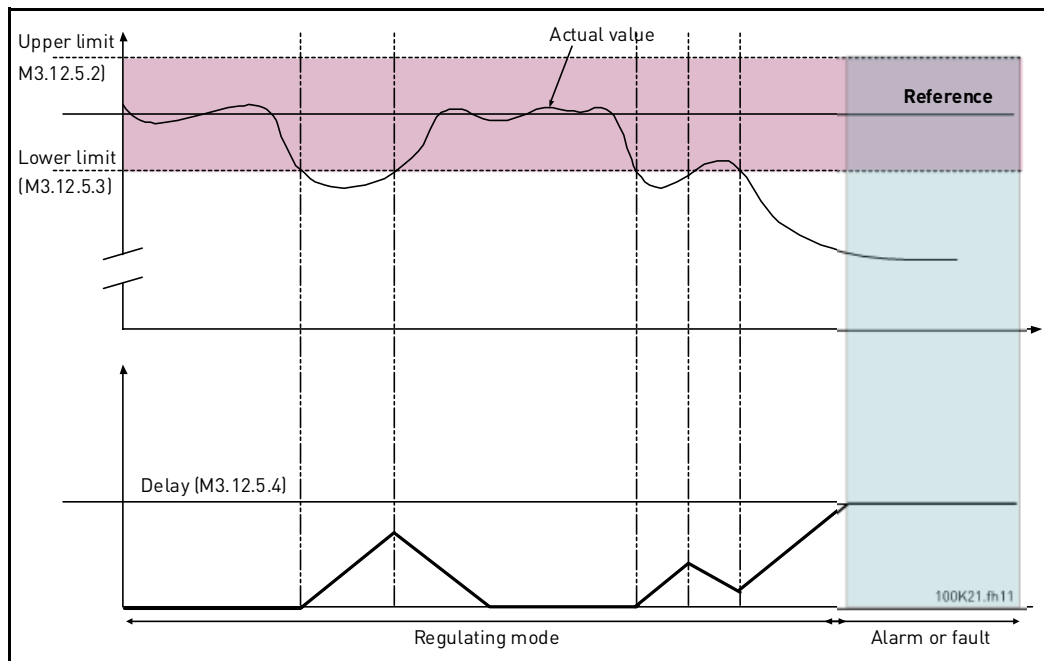

Figure 20. Process supervision

Upper and lower limits around the reference are set. When the actual value goes above or below these a counter starts counting up towards the Delay (M3.12.5.4). When the actual value is within the allowed area the same counter counts down instead. Whenever the counter is higher than the Delay an alarm or fault (depending on the selected response) is generated.

PRESSURE LOSS COMPENSATION

Figure 21. Position of pressure sensor

If pressurizing a long pipe with many outlets, the best place for the sensor would probably be halfway down the pipe (Position 2). However, sensors might, for example, be placed directly after the pump. This will give the right pressure directly after the pump, but farther down in the pipe the pressure will drop depending on the flow.

M3.12.6.1 ENABLE SETPOINT 1
M3.12.6.2 SETPOINT 1 MAX COMPENSATION

The sensor is placed in Position 1. The pressure in the pipe will remain constant when we have no flow. However, with flow, the pressure will drop farther down in the pipe. This can be compensated by raising the setpoint as the flow increases. In this case, the flow is estimated by the output frequency and the setpoint is linearly increased with the flow as in the figure below.

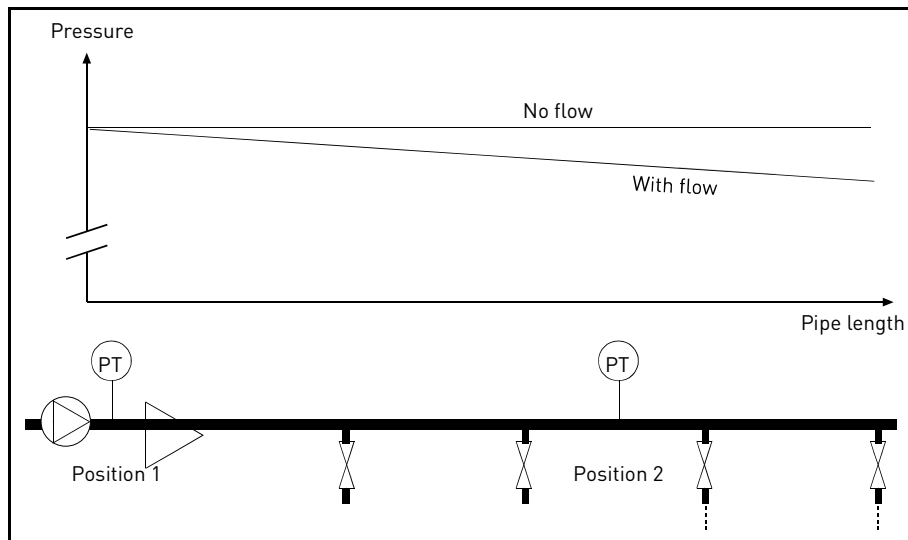
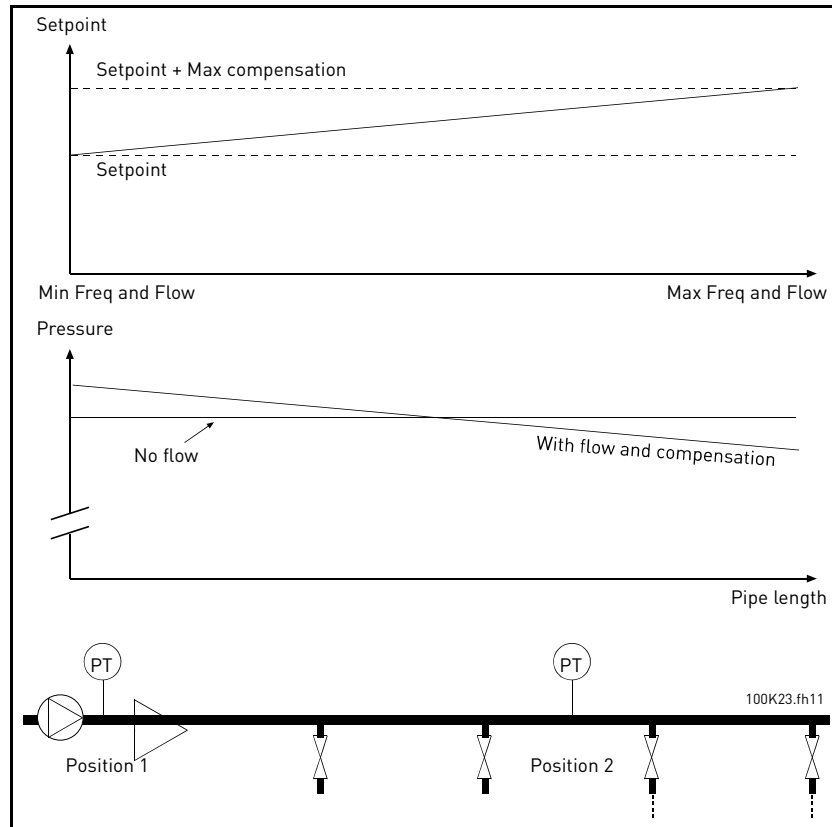

Figure 22. Enable setpoint 1 for pressure loss compensation

PUMP SOFT FILL FUNCTION

The Soft Fill function is used, for example, to avoid pressure pikes, the so-called "water hammers" in pipes when the drive starts to regulate. If not controlled, these pikes might lead to damaged pipes. See more information on page 80.

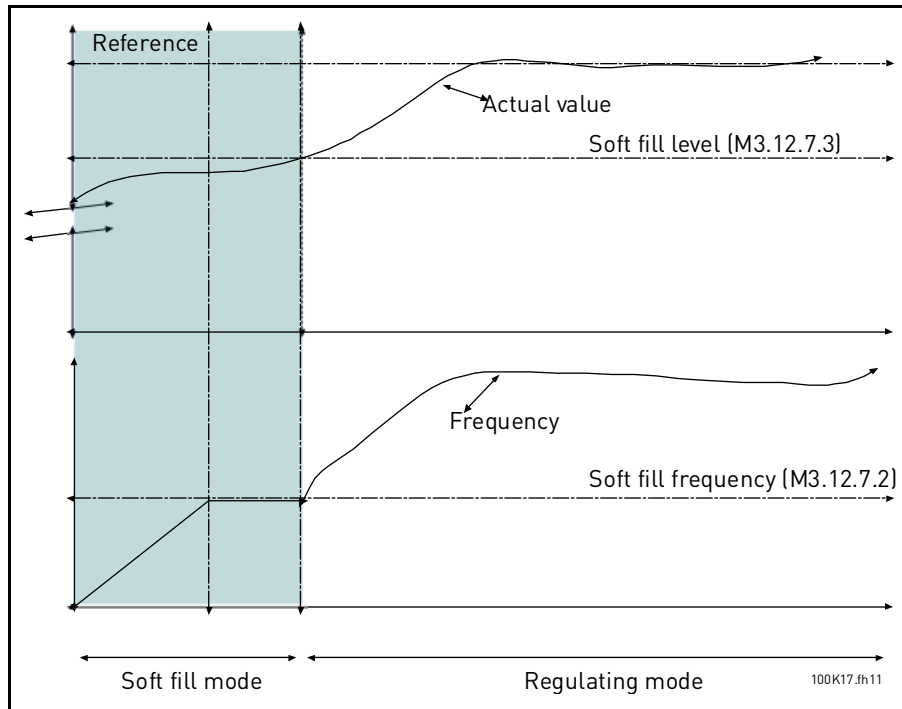

Figure 23.

The drive runs at the *Soft fill frequency* (M3.12.7.2) until the actual value reaches the *Soft fill level* (M3.12.7.3). After this the drive starts to regulate. If the *Soft fill level* isn't reached within the *Soft fill timeout* (M3.12.7.4) an alarm or fault is triggered according to the *Soft fill supervision response* (M3.9.16).

NOTE: The Soft fill function is disabled if parameter M3.12.1.8 *Error inversion* is set to *Inverted*.

MULTI-PUMP USE

A motor/motors are connected/disconnected if the PID controller is not able to keep the process value or feedback within the defined bandwidth around the setpoint.

Criteria for connecting/adding motors (also see Figure 24):

- Feedback value outside the bandwidth area.
- Regulating motor running at a “close-to-max” frequency (-2Hz)
- Conditions above are fulfilled for a time longer than the bandwidth delay
- There are more motors available

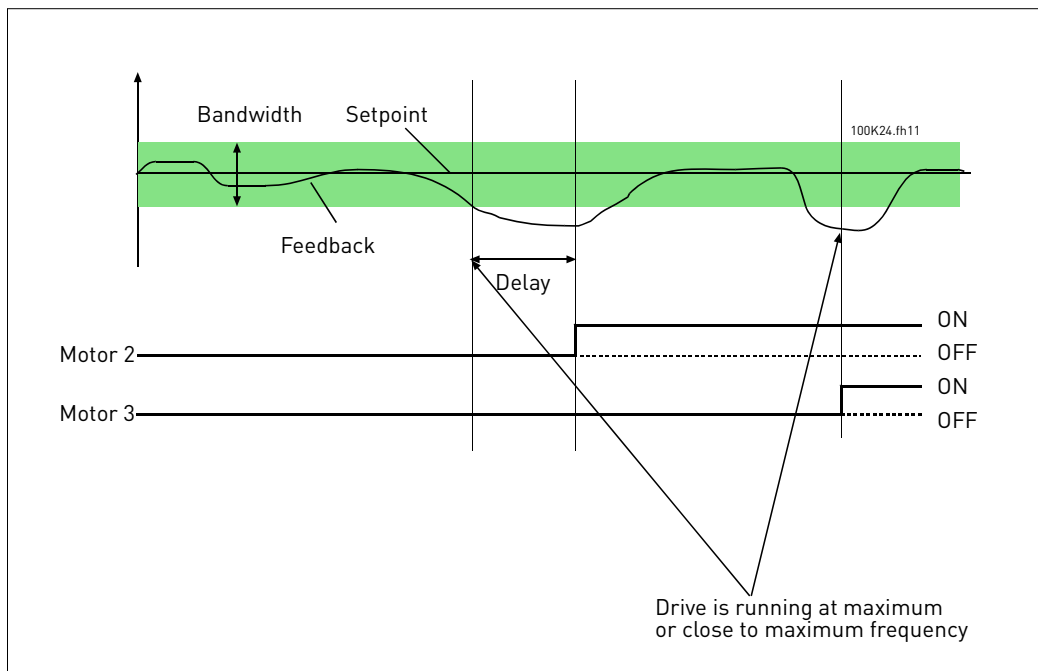

Figure 24.

Criteria for disconnecting/removing motors:

- Feedback value outside bandwidth area.
- Regulating motor running at a “close-to-min” frequency (+2 Hz)
- Conditions above are fulfilled for a time longer than the bandwidth delay
- There are more motors running than the regulating one.

M3.14.2 INTERLOCK FUNCTION

Interlocks can be used to tell the Multi Pump system that a motor is not available e.g. because of the motor is removed from the system for maintenance or bypassed for manual control.

Enable this function to use the interlocks. Choose the needed status for each motor by digital inputs (parameters M3.5.1.26 to M3.5.1.29). If the input is closed (TRUE) the motor is available for the Multi Pump system, otherwise it will not be connected by the Multi Pump logic.

EXAMPLE OF THE INTERLOCK LOGIC:

If the motor starting order is

1->2->3->4->5

Now, the interlock of motor **3** is removed, i.e. the value of parameter M3.5.1.27 is set to FALSE, the order changes to:

1->2->4->5.

If motor **3** is taken into use again (changing the value of parameter M3.5.1.27 to TRUE) the system runs on without stopping and motor **3** is placed last in the sequence:

1->2->4->5->3

As soon as the system is stopped or goes to sleep mode for the next time, the sequence is updated to its original order.

1->2->3->4->5

M3.14.3 INCLUDE FC

Selection	Selection name	Description
0	Disabled	Motor 1 (motor connected to drive) is always frequency controlled and not affected by interlocks.
1	Enabled	All motors can be controlled and are affected by interlocks.

WIRING

There are two different ways to make the connections depending on whether selection **0** or **1** is set as parameter value.

Selection 0, Disabled:

The drive or the regulating motor is not included in the autochange or interlocks logic. The drive is directly connected to motor 1 as in Figure 25 below. The other motors are auxiliary ones connected to the mains by contactors and controlled by relays in the drive.

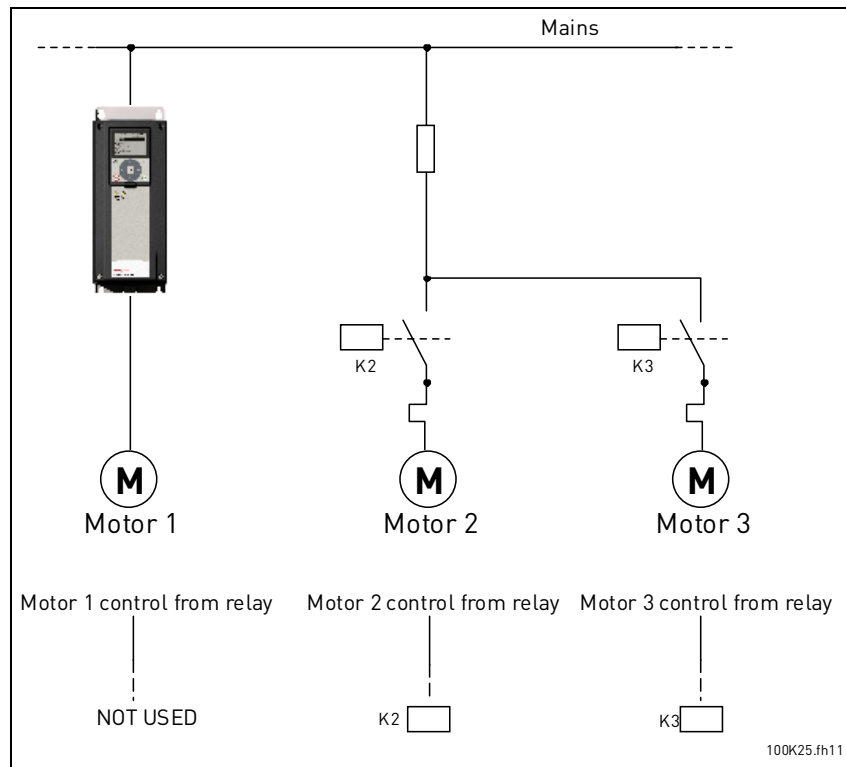

Figure 25.

Selection 1, Enabled:

If the regulating motor needs to be included in the autochange or interlock logic make the connection according to Figure 26 below.

Every motor is controlled with one relay but the contactor logic takes care that the first connected motor is always connected to the drive and next to the mains.

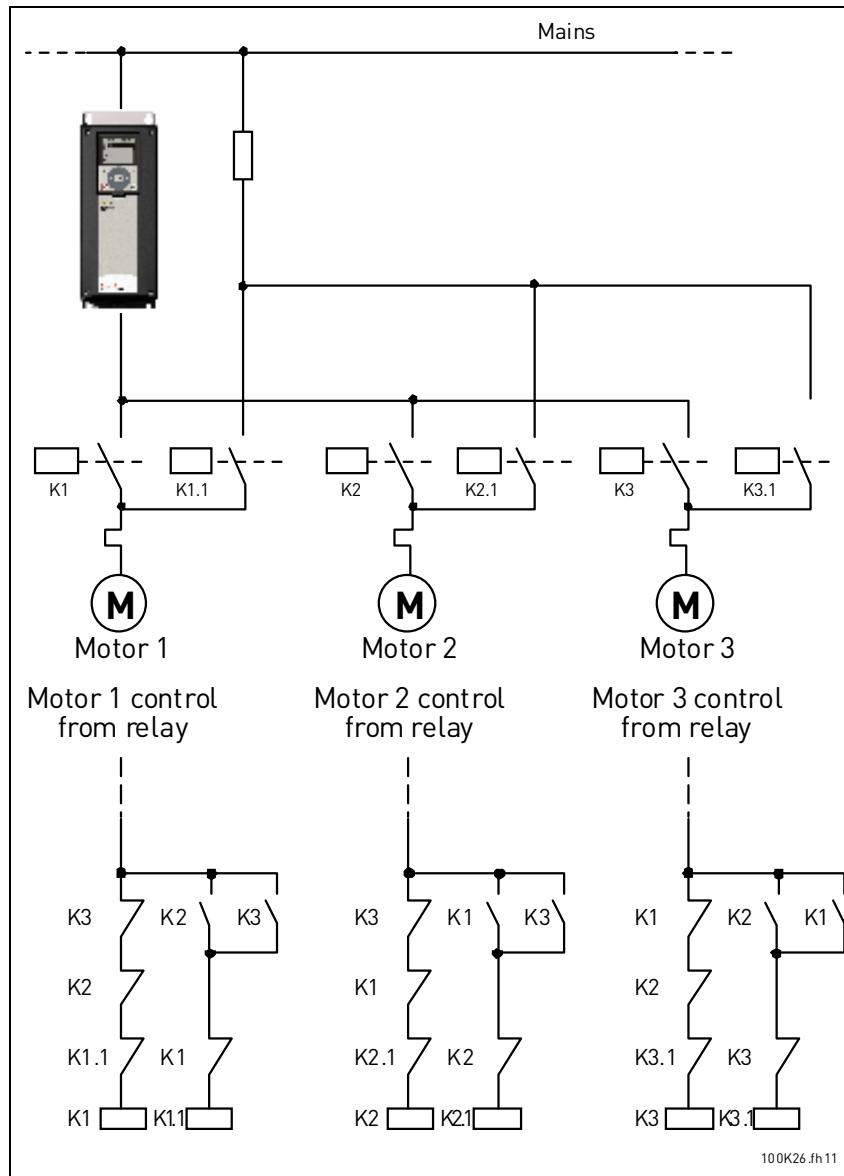

Figure 26.

M3.14.4 AUTOCHANGE

Selection	Selection name	Description
0	Disabled	The priority/starting order of the motors is always 1-2-3-4-5 in normal operation. It might have changed during run if interlocks have been removed and added again, but the priority/order is always restored after a stop.
1	Enabled	The priority is changed at certain intervals to get an equal wear on all motors. The intervals of the auto-change can be changed (M3.14.5). You can also set a limit of how many motors are allowed to run (M3.14.7) as well as for the maximum frequency of the regulating drive when the autochange is done (M3.14.6). If the autochange interval M3.14.5 has expired, but the frequency and motor limits are not fulfilled, the autochange will be postponed until all conditions are met (this is to avoid e.g. sudden pressure drops because of the system performing an autochange when there is a high capacity demand at a pump station).

EXAMPLE:

In the autochange sequence after the autochange has taken place, the motor with the highest priority is placed last and the others are moved up by one place:

Starting order/priority of motors: **1->2->3->4->5**

--> *Autochange* -->

Starting order/priority of motors: **2->3->4->5->1**

--> *Autochange* -->

Starting order/priority of motors: **3->4->5->1->2**

3.7 HVAC Application - Fault tracing

When an unusual operating condition is detected by the drive control diagnostics, the drive initiates a notification visible, for example, on the keypad. The keypad will show the code, the name and a short description of the fault or alarm.

The notifications vary in consequence and required action. *Faults* make the drive stop and require reset of the drive. *Alarms* inform of unusual operating conditions but the drive will continue running. *Infos* may require resetting but do not affect the functioning of the drive.

For some faults you can program different responses in the application. See parameter group Protections.

The fault can be reset with the *Reset button* on the control keypad or via the I/O terminal. The faults are stored in the Fault history menu which can be browsed. The different fault codes you will find in the table below.

NOTE: When contacting distributor or factory because of a fault condition, always write down all texts and codes on the keypad display.

3.7.1 Fault appears

When a fault appears and the drive stops examine the cause of fault, perform the actions advised here and reset the fault either

1. with a long (1 s) press on the *Reset button* on the keypad or
2. by entering the *Diagnostics Menu (M4)*, entering *Reset faults (M4.2)* and selecting *Reset faults* parameter.

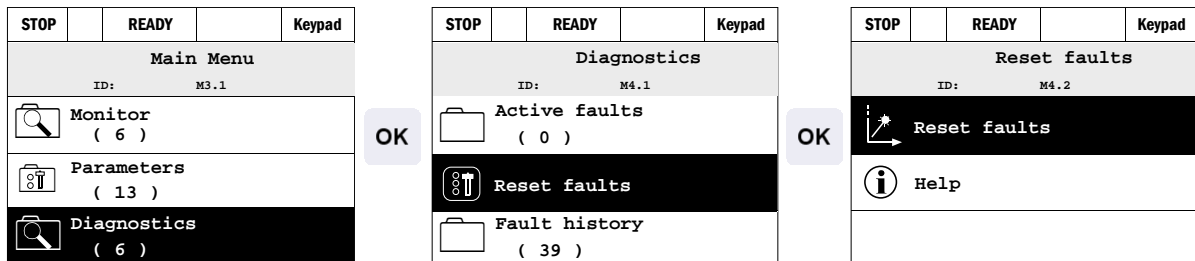

3.7.2 Fault codes

Fault code	ID	Fault name	Possible cause	Remedy
1		Overcurrent	<p>Drive has detected too high a current ($>4 \cdot I_H$) in the motor cable:</p> <ul style="list-style-type: none"> sudden heavy load increase short circuit in motor cables unsuitable motor <p>Fault ID: 1 = Hardware fault 2 = Software fault</p>	<p>Check loading. Check motor. Check cables. Make identification run.</p>
2		Overvoltage	<p>The DC-link voltage has exceeded the limits defined.</p> <ul style="list-style-type: none"> too short a deceleration time high overvoltage spikes in supply <p>Fault ID: 10 = Hardware fault 11 = Software fault</p>	<p>Make deceleration time longer. Use brake chopper or brake resistor (available as options) Activate overvoltage controller. Check input voltage.</p>
3		Earth fault	<p>Current measurement has detected that the sum of motor phase current is not zero.</p> <ul style="list-style-type: none"> insulation failure in cables or motor <p>Fault ID: 20 = Hardware fault 21 = Software fault</p>	<p>Check motor cables and motor.</p>
5		Charging switch	<p>The charging switch is open, when the START command has been given.</p> <ul style="list-style-type: none"> faulty operation component failure <p>Fault ID: 40 = Hardware fault</p>	<p>Reset the fault and restart. Should the fault re-occur, contact the distributor near to you.</p>
7		Saturation	<p>Various causes:</p> <ul style="list-style-type: none"> defective component brake resistor short-circuit or overload <p>Fault ID: 60 = Hardware fault</p>	<p>Cannot be reset from keypad. Switch off power. DO NOT RE-CONNECT POWER! Contact factory. If this fault appears simultaneously with Fault 1, check motor cables and motor</p>
8		System fault	<ul style="list-style-type: none"> Component failure Faulty operation <p>Fault ID: 600 = Communication between control board and power unit has failed 601 = Communication between control board and power unit has interference but is still working [ALARM] 602 = Watchdog has reset the CPU 603 = Voltage of auxiliary power in power unit is too low 604 = Phase fault: Voltage of an output phase does not follow the reference</p>	<p>Reset the fault and restart. Should the fault re-occur, contact the distributor near to you.</p>

Fault code	ID	Fault name	Possible cause	Remedy
9		Undervoltage	DC-link voltage is under the voltage limits defined. <ul style="list-style-type: none"> most probable cause: too low a supply voltage AC drive internal fault defect input fuse external charge switch not closed Fault ID: 80 = Fault 81 = Alarm	In case of temporary supply voltage break reset the fault and restart the drive. Check the supply voltage. If it is adequate, an internal failure has occurred. Contact the distributor near to you.
12		Brake chopper supervision	<ul style="list-style-type: none"> no brake resistor installed brake resistor is broken brake chopper failure Fault ID: 110 = Hardware fault 111 = Brake chopper saturation alarm	Check brake resistor and cabling. If the these are ok, the chopper is faulty. Contact the distributor near to you.
13		Drive under-temperature	Too low temperature measured in power unit's heatsink or board. Heatsink temperature is under -10°C. Fault ID: 120 = Fault 121 = Alarm	
14		Drive overtemperature	Too low temperature measured in power unit's heatsink or board. Heatsink temperature is over 100°C. Fault ID: 120 = Fault 121 = Alarm	Check the correct amount and flow of cooling air. Check the heatsink for dust. Check the ambient temperature. Make sure that the switching frequency is not too high in relation to ambient temperature and motor load.
15		Motor stalled	Motor stall protection has tripped. Fault ID: 140 = Fault	Check motor and load.
16		Motor overtemperature	Motor overheating has been detected by drive motor temperature model. Motor is overloaded. Fault ID: 150 = Fault	Decrease motor load. If no motor overload exists, check the temperature model parameters.
17		Motor underload	Motor underload protection has tripped. Fault ID: 160 = Fault	Check load.
41		IGBT temperature	IGBT temperature (unit temperature + I ₂ T) is too high. Fault ID: 400 = Fault	Check loading. Check motor size. Make identification run.
51	1051	External fault	Digital input	
52	1052 1352	Keypad communication fault	The connection between the control keypad and drive is broken	Check keypad connection and possible keypad cable

Fault code	ID	Fault name	Possible cause	Remedy
53	1053	Fieldbus communication fault	The data connection between the fieldbus master and fieldbus board is broken	Check installation and fieldbus master.
54	1354 1454 1654 1754	Slot A fault Slot B fault Slot D fault Slot E fault	Defective option board or slot	Check board and slot
65	1065	PC communication fault	The data connection between the PC and drive is broken	
66	1066	Thermistor fault	The thermistor input has detected an increase of motor temperature	Check motor cooling and load. Check thermistor connection (If thermistor input is not in use it has to be short circuited)
68	1301	Maintenance counter 1 alarm	Maintenance counter has reached the alarm limit.	Carry out the needed maintenance and reset counter.
	1302	Maintenance counter 1 fault	Maintenance counter has reached the fault limit.	
	1303	Maintenance counter 2 alarm	Maintenance counter has reached the alarm limit.	
	1304	Maintenance counter 2 fault	Maintenance counter has reached the fault limit.	
	1305	Maintenance counter 3 alarm	Maintenance counter has reached the alarm limit.	
	1306	Maintenance counter 3 fault	Maintenance counter has reached the fault limit.	
101	1101	Process supervision fault (PID1)	PID controller: Feedback value outside of supervision limits (and the delay if set).	
105	1105	Process supervision fault (PID2)	PID controller: Feedback value outside of supervision limits (and the delay if set).	

Table 54. Fault codes and descriptions

3.8 Fieldbus process data out

Values to monitor through fieldbus are:

Data	Value	Scale
Process Data Out 1	Output frequency	0.01 Hz
Process Data Out 2	Motor speed	1 rpm
Process Data Out 3	Motor current	0.1 A
Process Data Out 4	Motor torque	0.1 %
Process Data Out 5	Motor power	0.1 %
Process Data Out 6	Motor voltage	0.1 V
Process Data Out 7	DC-link voltage	1 V
Process Data Out 8	Last active fault code	

Table 55. Fieldbus Process Data Out

Automation and Control Solutions

Honeywell International Inc.
1985 Douglas Drive North
Golden Valley, MN 55422
customer.honeywell.com

Honeywell Limited-Honeywell Limitée
35 Dynamic Drive
Toronto, Ontario M1V 4Z9

Honeywell