

13

ZONE VALVES

- Designed to fit in compact areas where on/off control is required.
- Actuator installation is a snap with an easy, one-handed removal or engagement.
- Actuator has a synchronous motor that winds the return spring and moves the valve paddle to the desired position.
- Economical operation allows for low current draw and multiple valves per transformer.
- Enhanced motion gear action reduces motor wear and provides smooth, quiet operation with no water hammer and dependable close off.

Applications

For high rise and commercial applications where higher close-off is required: fin tube casing, fan coils, radiant panels and duct coils. Zone valves control the flow of hot and chilled water through coils and heat exchangers.



Zone Valve Nomenclature

ZONE2	15	N	-10	+ZONE24NC	-S
Valve Zone2 = 2-way Zone3 = 3-way	Valve Size 15 = ½" 20 = ¾" 25 = 1"	End Fitting N = NPT Female Connection S = Sweat Connection	C_v Valve -10 = 1.0 -25 = 2.5 -35 = 3.5 -50 = 5.0 -80 = 8.0	Actuator Type 24NC = 24 Volt Normally Closed 24NO = 24 Volt Normally Open 120NC = 120 Volt Normally Closed 120NO = 120 Volt Normally Open	-S = Built-in Auxiliary Switch

Ordering Example

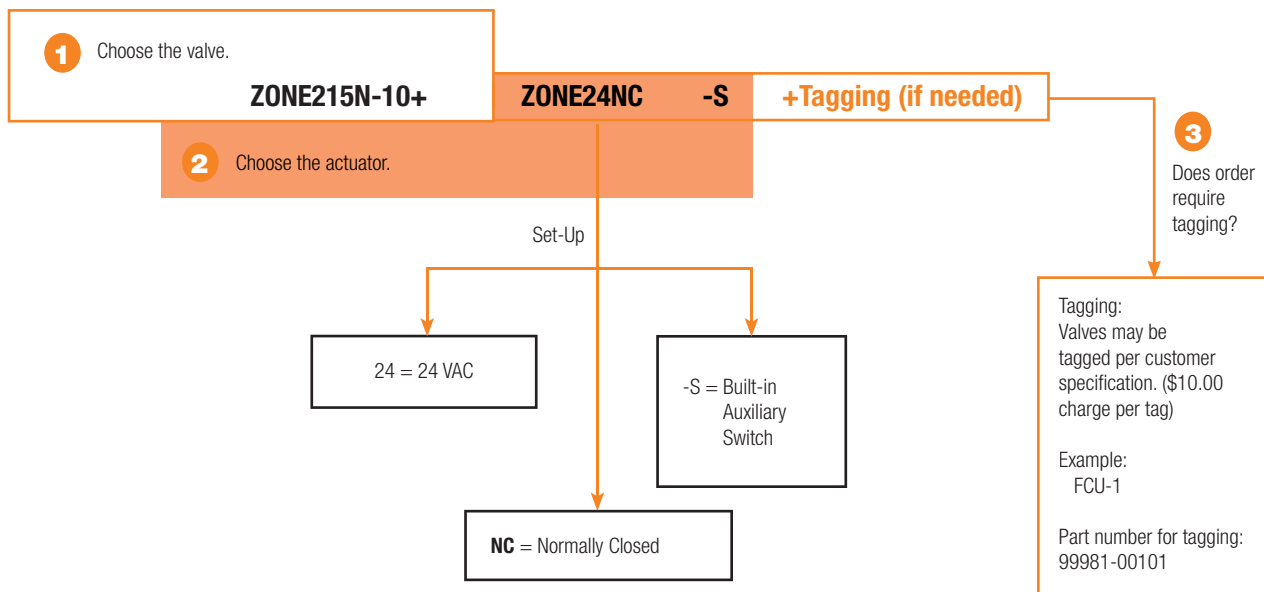

4 Complete Ordering Example: ZONE215N-10+ZONE24NC-S

Control Valve Product Range

Zone Valve Product Range Z2.., Z3..

C _v	Valve Nominal Size		Type		Suitable Actuators			
	Inches	DN [mm]	2-way NPT	2-way Sweat	Normally Closed		Normally Open	
1	½	15	ZONE215N-10	ZONE215S-10	Zone	Zone (with Switch)	Zone	Zone (with Switch)
2.5	½	15	ZONE215N-25	ZONE215S-25				
3.5	½	15	ZONE215N-35	ZONE215S-35				
3.5	¾	20	ZONE220N-35	ZONE220S-35				
5	¾	20	ZONE220N-50	ZONE220S-50				
8	1	25	ZONE225N-80	ZONE225S-80				



C _v	Valve Nominal Size		Type		Suitable Actuators	
	Inches	DN [mm]	3-way NPT	3-way Sweat	Normally Closed	
1	½	15	ZONE315N-10	ZONE315S-10	Zone	Zone (with Switch)
2.5	½	15	ZONE315N-25	ZONE315S-25		
3.5	½	15	ZONE315N-35	ZONE315S-35		
3.5	¾	20	ZONE320N-35	ZONE320S-35		
5	¾	20	ZONE320N-50	ZONE320S-50		
8	1	25	ZONE325N-80	ZONE325S-80		

Mode of Operation

Zone valves provide a convenient way to create individual zones or equipment isolation in a hydronic system. Utilizing one pump along with multiple zone valves, flow can be started, stopped, or diverted through the system to provide individual room or area comfort control and energy savings.

Product Features

Zone valve is designed to fit in compact areas where on/off control is required using 24 VAC or 120 VAC.

Actuator Specifications

Control type	on/off
Manual override	all versions
Electrical connection	6" [15cm] wire lead 120 V; 18" [45 cm] wire lead 24 V

Valve Specifications

Service	chilled or hot water, 50% glycol
Flow characteristic	
Two-way	on/off
Three-way	on/off, diverting
Sizes	½", ¾" and 1"
End fitting	NPT female ends or sweat
Materials	
Body	forged brass
Stem	stainless steel
Seals	EPDM
Media temp range	32°F to 212°F [0°C to 100°C]
Body pressure rating	300 psi
Close off pressure	20-75 psi
Leakage	ANSI Class III 0.1%

INSTALLATION

The valve can be installed vertically or horizontally, but not below horizontal.

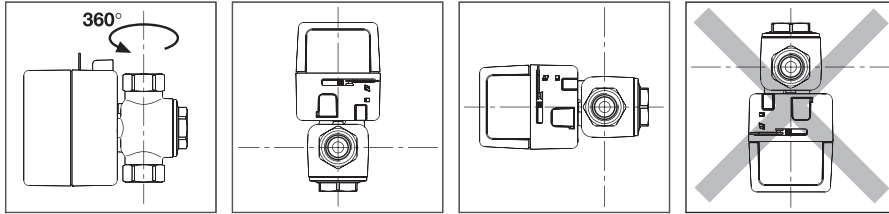

- A 3-way valve cannot be transformed into a 2-way valve and visa versa.
- The 2-way flow is from A to B (see diagram below) and must be installed so the paddle closes against the direction of flow.
- The 2-way valves can be installed on the supply or on the return; for correct installation it is necessary to respect the direction of flow indicated by the arrow on the valve body.
- The NC versions have an override handle.
- 3-way zone valves can be fitted with NC actuator only (rotate the valve body 180° for NO application).

	2-WAY	3-WAY
N.C. without power	Port "A" closed	Port "A" closed Port "B" open Port "AB" open
N.C. open with power	Port "A" open	Port "A" open Port "B" closed Port "AB" open
N.C. manually open	Port "A" open	Port "A" open Port "B" open Port "AB" open

2-way Valve

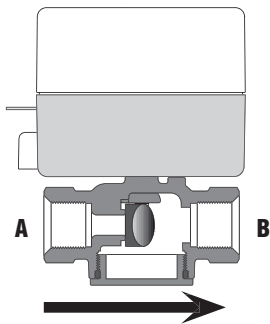

Normally closed actuator

3-way Valve

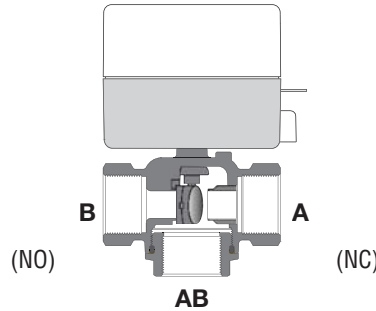

Normally closed actuator

Normally closed actuator

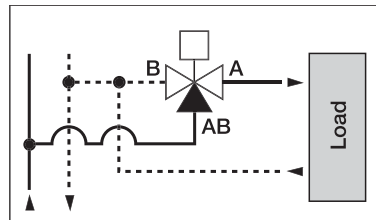

Installed on the supply in diverting configuration

Normally closed actuator

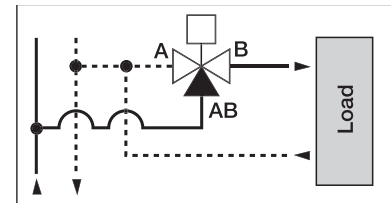

Installed on the supply in diverting configuration

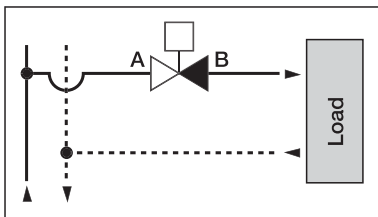

Installed on the supply

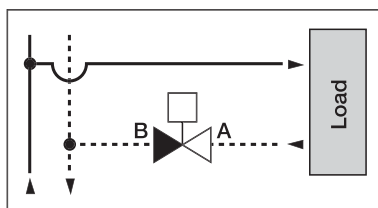

Installed on the return

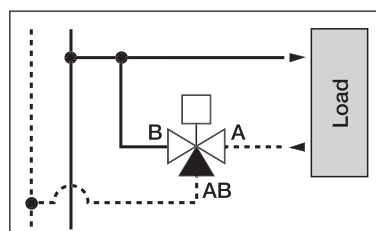

Installed on the return

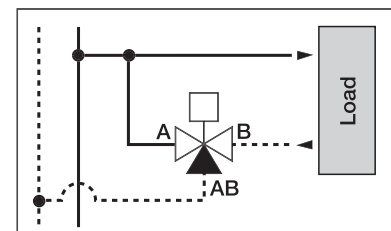

Installed on the return

Valve Specifications

Service	chilled or hot water, 50% glycol
Flow characteristic	two-way: on/off three-way: on/off, diverting
Sizes	½", ¾" and 1"
End fitting	female NPT or sweat
Materials:	
Body	forged brass
Stem	stainless steel
Seats	EPDM
Seals	machined brass
Pressure rating	300 psi
Media temp. range	32°F to 212°F [0°C to 100°C]
Leakage	ANSI class III 0.1%
Cv rating	see chart below for values



Spring Return Actuators



ACTUATOR PART #	ZONE24NC		ZONE24NO		ZONE24NC-S		ZONE24NO-S		
Control type	On/Off		On/Off		On/Off		On/Off		
Manual override	•		•		•		•		
Running time	Motor	20-40 seconds		20-40 seconds		20-40 seconds		20-40 seconds	
	Spring	5 seconds		5 seconds		5 seconds		5 seconds	
Noise level	max. 35 dB(A)		max. 35 dB(A)		max. 35 dB(A)		max. 35 dB(A)		
ELECTRICAL CONNECTION:									
24 V 18" wire	•		•		•		•		
	Valve Nominal Size								
Zone Valve Model #	Cv Rating	Inches	DN mm	Close-Off psi					
2-WAY WITH NPT FEMALE CONNECTION									
ZONE215N-10	1	½	15	75	\$171.00	\$171.00	\$184.00	\$184.00	
ZONE215N-25	2.5	½	15	50	\$171.00	\$171.00	\$184.00	\$184.00	
ZONE215N-35	3.5	½	15	30	\$171.00	\$171.00	\$184.00	\$184.00	
ZONE220N-35	3.5	¾	20	30	\$189.00	\$189.00	\$201.00	\$201.00	
ZONE220N-50	5	¾	20	25	\$189.00	\$189.00	\$201.00	\$201.00	
ZONE225N-80	8	1	25	20	\$243.00	\$243.00	\$256.00	\$256.00	
3-WAY WITH NPT FEMALE CONNECTION									
ZONE315N-10	1	½	15	75	\$189.00	†	\$201.00	†	
ZONE315N-25	2.5	½	15	50	\$189.00	†	\$201.00	†	
ZONE315N-35	3.5	½	15	30	\$189.00	†	\$201.00	†	
ZONE320N-35	3.5	¾	20	30	\$203.00	†	\$215.00	†	
ZONE320N-50	5	¾	20	25	\$203.00	†	\$215.00	†	
ZONE325N-80	8	1	25	20	\$259.00	†	\$272.00	†	
2-WAY WITH SWEAT CONNECTION									
ZONE215S-10	1	½	15	75	\$167.00	\$167.00	\$180.00	\$180.00	
ZONE215S-25	2.5	½	15	50	\$167.00	\$167.00	\$180.00	\$180.00	
ZONE215S-35	3.5	½	15	30	\$167.00	\$167.00	\$180.00	\$180.00	
ZONE220S-35	3.5	¾	20	30	\$180.00	\$180.00	\$194.00	\$194.00	
ZONE220S-50	5	¾	20	25	\$180.00	\$180.00	\$194.00	\$194.00	
ZONE225S-80	8	1	25	20	\$236.00	\$236.00	\$250.00	\$250.00	
3-WAY WITH SWEAT CONNECTION									
ZONE315S-10	1	½	15	75	\$182.00	†	\$196.00	†	
ZONE315S-25	2.5	½	15	50	\$182.00	†	\$196.00	†	
ZONE315S-35	3.5	½	15	30	\$182.00	†	\$196.00	†	
ZONE320S-35	3.5	¾	20	30	\$198.00	†	\$211.00	†	
ZONE320S-50	5	¾	20	25	\$198.00	†	\$211.00	†	
ZONE325S-80	8	1	25	20	\$250.00	†	\$261.00	†	

† Three-way valve can be installed in NC or NO configuration using the NC actuator.

067001-04/13 - Subject to change. © Belimo Aircontrols (USA), Inc.

ZONE VALVES

Electronic Zone Valves, Spring Return Actuators

2-way and 3-way Valves with NPT or Sweat Connection



Valve Specifications

Service	chilled or hot water, 50% glycol
Flow characteristic	two-way: on/off three-way: on/off, diverting
Sizes	½", ¾" and 1"
End fitting	female NPT or sweat
Materials:	
Body	forged brass
Stem	stainless steel
Seats	EPDM
Seals	machined brass
Pressure rating	300 psi
Media temp. range	32°F to 212°F [0°C to 100°C]
Leakage	ANSI class III 0.1%
Cv rating	see chart below for values



Spring Return Actuators



ACTUATOR PART #	ZONE120NC	ZONE120NO	ZONE120NC-S	ZONE120NO-S
Control type	On/Off	On/Off	On/Off	On/Off
Manual override	•	•	•	•
Running time	Motor	20-40 seconds	20-40 seconds	20-40 seconds
	Spring	5 seconds	5 seconds	5 seconds
Noise level	max. 35 dB(A)	max. 35 dB(A)	max. 35 dB(A)	max. 35 dB(A)

ELECTRICAL CONNECTION:

120 V 6" wire	•	•	•	•
---------------	---	---	---	---

Zone Valve Model #	Cv Rating	Valve Nominal Size			Close-Off psi
		VNS IN	DN mm		

2-WAY WITH NPT FEMALE CONNECTION

ZONE215N-10	1	½	15	75	\$171.00	\$171.00	\$184.00	\$184.00
ZONE215N-25	2.5	½	15	50	\$171.00	\$171.00	\$184.00	\$184.00
ZONE215N-35	3.5	½	15	30	\$171.00	\$171.00	\$184.00	\$184.00
ZONE220N-35	3.5	¾	20	30	\$189.00	\$189.00	\$201.00	\$201.00
ZONE220N-50	5	¾	20	25	\$189.00	\$189.00	\$201.00	\$201.00
ZONE225N-80	8	1	25	20	\$243.00	\$243.00	\$256.00	\$256.00

3-WAY WITH NPT FEMALE CONNECTION

ZONE315N-10	1	½	15	75	\$189.00	†	\$201.00	†
ZONE315N-25	2.5	½	15	50	\$189.00	†	\$201.00	†
ZONE315N-35	3.5	½	15	30	\$189.00	†	\$201.00	†
ZONE320N-35	3.5	¾	20	30	\$203.00	†	\$215.00	†
ZONE320N-50	5	¾	20	25	\$203.00	†	\$215.00	†
ZONE325N-80	8	1	25	20	\$259.00	†	\$272.00	†

2-WAY WITH SWEAT CONNECTION

ZONE215S-10	1	½	15	75	\$167.00	\$167.00	\$180.00	\$180.00
ZONE215S-25	2.5	½	15	50	\$167.00	\$167.00	\$180.00	\$180.00
ZONE215S-35	3.5	½	15	30	\$167.00	\$169.00	\$180.00	\$180.00
ZONE220S-35	3.5	¾	20	30	\$180.00	\$180.00	\$194.00	\$194.00
ZONE220S-50	5	¾	20	25	\$180.00	\$180.00	\$196.00	\$194.00
ZONE225S-80	8	1	25	20	\$236.00	\$236.00	\$250.00	\$250.00

3-WAY WITH SWEAT CONNECTION

ZONE315S-10	1	½	15	75	\$182.00	†	\$196.00	†
ZONE315S-25	2.5	½	15	50	\$182.00	†	\$196.00	†
ZONE315S-35	3.5	½	15	30	\$182.00	†	\$196.00	†
ZONE320S-35	3.5	¾	20	30	\$198.00	†	\$211.00	†
ZONE320S-50	5	¾	20	25	\$198.00	†	\$211.00	†
ZONE325S-80	8	1	25	20	\$250.00	†	\$261.00	†

† Three-way valve can be installed in NC or NO configuration using the NC actuator.

067001 - 04/13 - Subject to change. © Belimo Aircontrols (USA), Inc.